

Rhinologie  
*Rhinology*

Rhinologie  
*Rinología*  
Rinologia

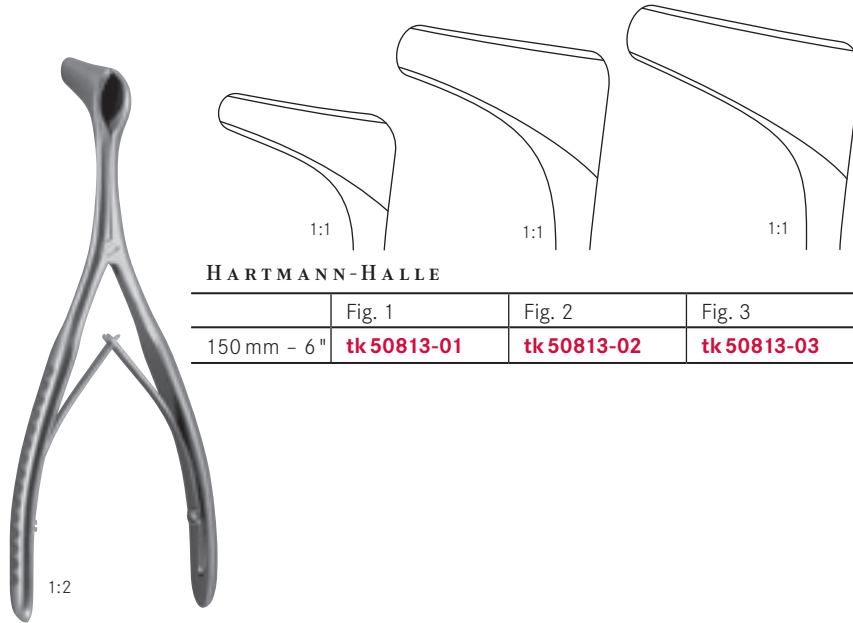

Nasenspekula | Spéculums nasaux  
*Nasal specula* | *Especulos nasales*  
 Specoli nasali



HARTMANN-HALLE

	Fig. 1	Fig. 2	Fig. 3
150 mm - 6"	<b>tk 50813-01</b>	<b>tk 50813-02</b>	<b>tk 50813-03</b>



TIECK-HALLE

135 mm - 5¼"	<b>tk 50822-13</b>	<b>tk 50823-13</b>
--------------	--------------------	--------------------

für Säuglinge  
*for babies*

pour nourrissons  
*para lactantes*  
 per lattanti

für Kleinkinder  
*for infants*

pour petits enfants  
*para niños pequeños*  
 per bambini



Alle Nasenspekula sind optional auch mit Feststellschraube erhältlich  
*All nasal specula are also available with locking screw*  
 Tous les spéculums nasaux sont aussi disponible avec une vis de fixation  
*Todos los especulos nasales son también disponibles con un tornillo de fijación*  
 Tutti gli speculi nasali sono disponibili anche con vite di fassaggio



Nasenspekula | Spéculums nasaux  
 Nasal specula | Especulos nasales  
 Specoli nasali

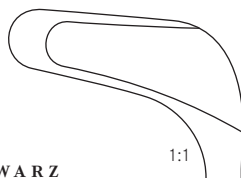
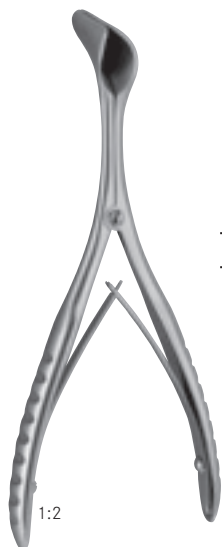

SCHWARZ  
 140 mm - 5½" tk 50811-14

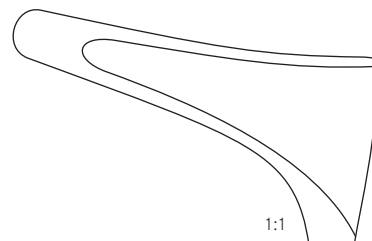
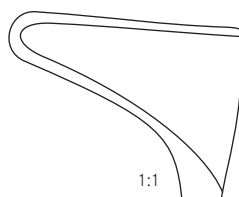
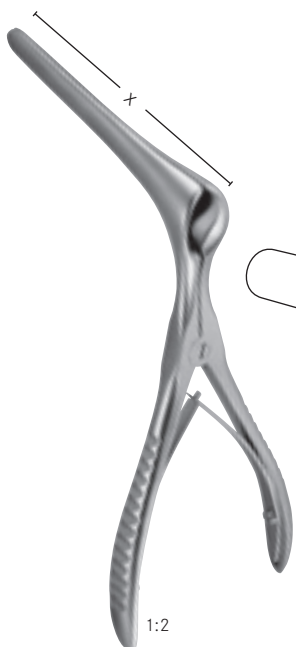

KILLIAN	
	Fig. 1
	x = 35 mm
130 mm - 5"	tk 50828-01
	Fig. 2
	x = 50 mm
	tk 50828-02

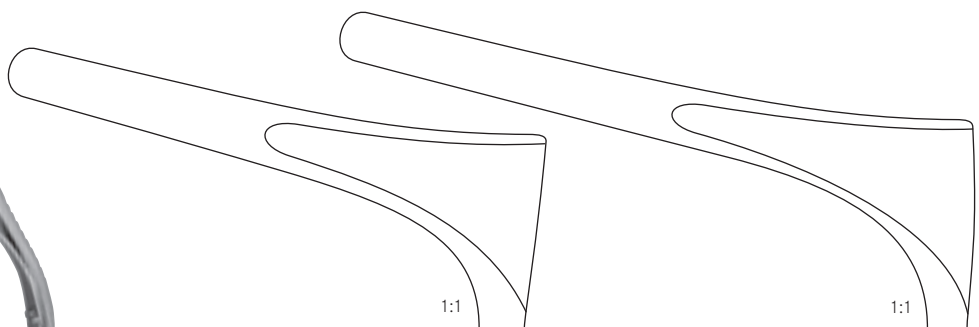

	Fig. 3
	x = 75 mm
130 mm - 5"	tk 50828-03
	Fig. 4
	x = 90 mm
	tk 50828-04



Alle Nasenspekula sind optional auch mit Feststellschraube erhältlich  
 All nasal specula are also available with locking screw  
 Tous les spéculems nasaux sont aussi disponible avec une vis de fixation  
 Todos los especulos nasales son también disponibles con un tornillo de fijación  
 Tutti gli speculi nasali sono disponibili anche con vite di fissaggio



Nasenspekula | Spéculums nasaux  
*Nasal specula* | *Especulos nasales*  
 Specoli nasali

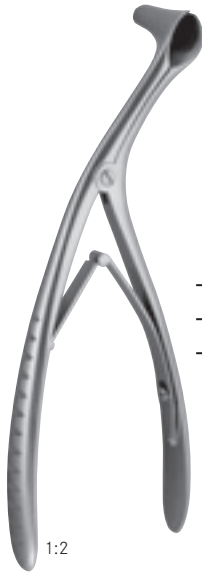

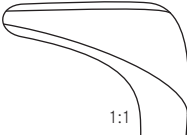
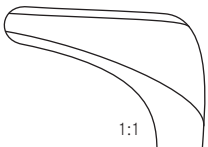
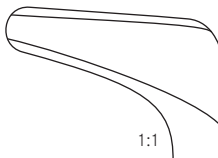
BECKMANN			
	 1:1	 1:1	 1:1
	Fig. 1	Fig. 2	Fig. 3
150 mm - 6"	<b>tk 50830-01</b>	<b>tk 50830-02</b>	<b>tk 50830-03</b>

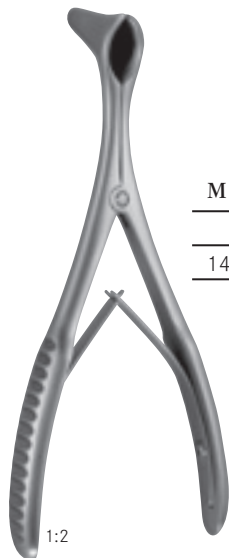

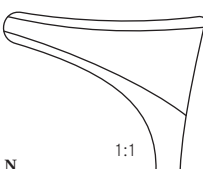
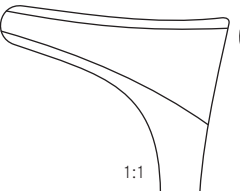
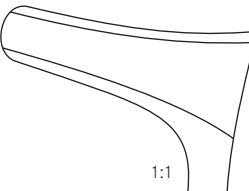
MOD. WIEN			
	 1:1	 1:1	 1:1
	Fig. 1	Fig. 2	Fig. 3
145 mm - 5¾"	<b>tk 50834-01</b>	<b>tk 50834-02</b>	<b>tk 50834-03</b>



Alle Nasenspekula sind optional auch mit Feststellschraube erhältlich  
*All nasal specula are also available with locking screw*  
 Tous les spéculums nasaux sont aussi disponible avec une vis de fixation  
*Todos los especulos nasales son también disponibles con un tornillo de fijación*  
 Tutti gli speculi nasali sono disponibili anche con vite di fissaggio



Nasenspekula | Spéculums nasaux  
*Nasal specula* | *Especulos nasales*  
 Specoli nasali



COTTLE	
Fig. 1	Fig. 2
x = 35 mm	x = 50 mm
150 mm - 6"	<b>tk 50836-35</b>

Fig. 3	Fig. 4
x = 75 mm	x = 90 mm
150 mm - 6"	<b>tk 50836-75</b>



COTTLE	
x = 45 mm	x = 75 mm
140 mm - 5½"	<b>tk 50840-45</b>

**Nasenseptumspikulum, schwarz verchromt**  
*Nasal septum speculum, black, chrome plated*  
 Spéculum pour la cloison nasale, chromé en noir  
*Especulo para el septo nasal, cromado en negro*  
 Specolo per il setto nasale, cromato nero



Alle Nasenspekula sind optional auch mit Feststellschraube erhältlich  
*All nasal specula are also available with locking screw*  
 Tous les spéculums nasaux sont aussi disponible avec une vis de fixation  
*Todos los especulos nasales son también disponibles con un tornillo de fijación*  
 Tutti gli specoli nasali sono disponibili anche con vite di fassaggio



Nasenspekula | Spéculums nasaux  
Nasal specula | Especulos nasales  
Specoli nasali



VOLTOLINI			
	Fig. 1	Fig. 2	Fig. 3
75 mm - 3"	<b>tk 50810-01</b>	<b>tk 50810-02</b>	<b>tk 50810-03</b>

Ohr- und Nasenpinzetten | Pincés auriculaires et nasaux  
Ear and nose dressing forceps | Pinzas auriculares y nasales  
Pinze auricolari e nasali

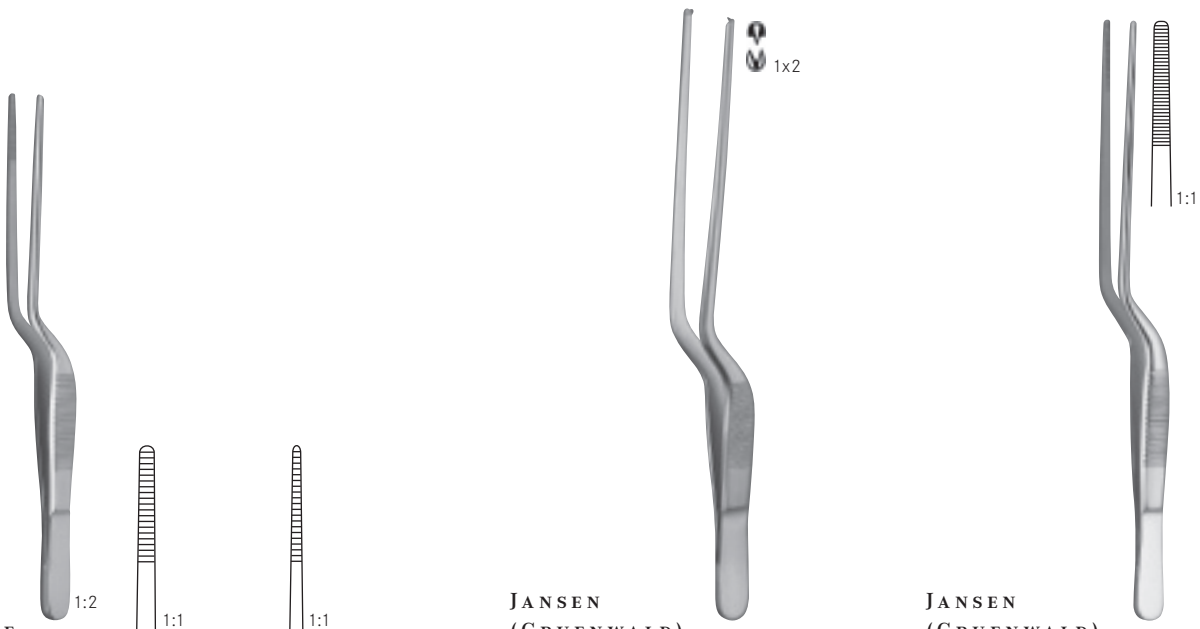

LUCAE		
140 mm - 5½"	<b>tk 11605-14</b>	<b>tk 11606-14</b>

JANSEN (GRUENWALD)	
160 mm - 6¼"	<b>tk 11609-16</b>
200 mm - 8"	<b>tk 11609-20</b>

JANSEN (GRUENWALD)	
160 mm - 6¼"	<b>tk 11607-16</b>
200 mm - 8"	<b>tk 11607-20</b>

Ohr- und Nasenpinzetten  
Ear and nose dressing forceps

Pinces auriculaires et nasaux  
Pinzas auriculares y nasales  
Pinze auricolari e nasali

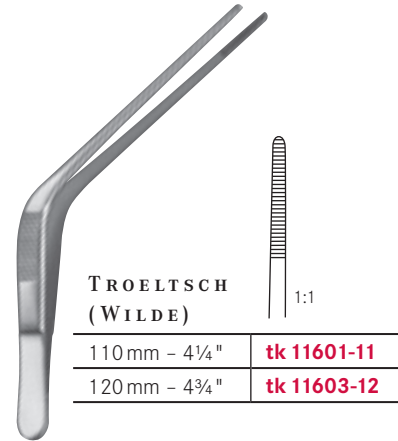
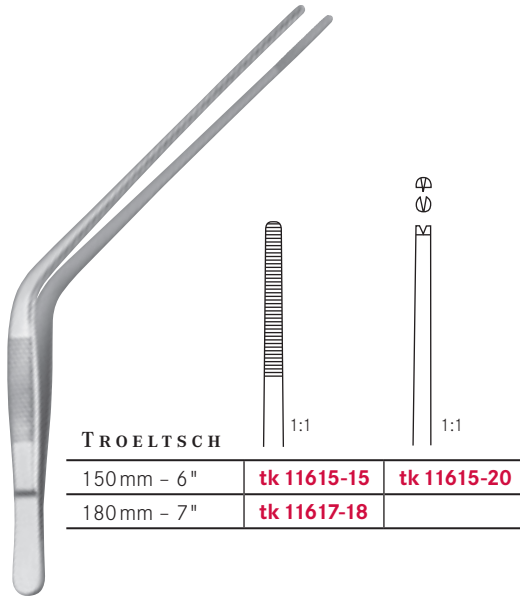

gekreuzt  
cross  
croisée  
cruzado  
crociato

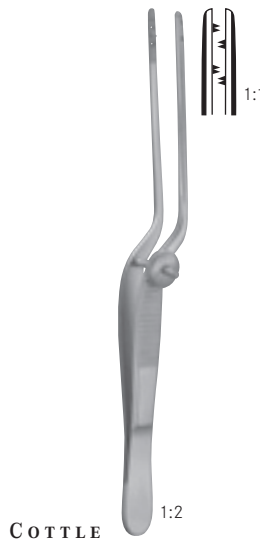

Columella Pinzette  
Columella forceps  
Pince à columella  
Pinza para columella  
Pinza per columella

Nasenscheren  
*Nasal scissors*

Ciseaux nasaux  
*Tijeras nasales*  
Forbici nasali



**SAILER**

170 mm - 6¾" **tk 9132-17**



**HEYMANN**

180 mm - 7" **tk 9137-18**



**FOMON**

130 mm - 5" **tk 9152-13**



**COTTLE**

160 mm - 6¼" **tk 9157-16**



Nasenschere | Ciseaux nasales  
 Nasal scissors | Tijera nasal  
 Forbice nasale

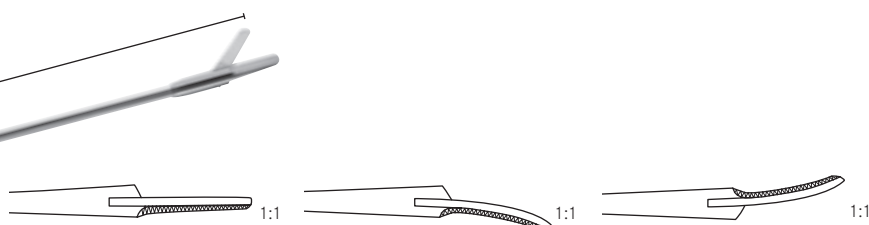
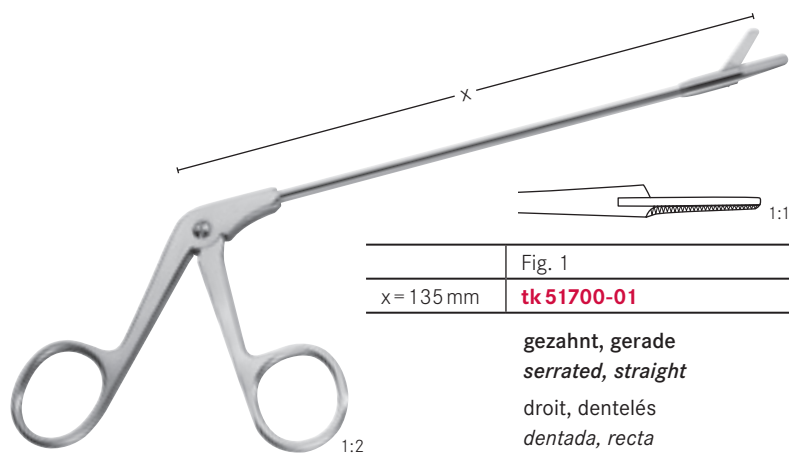

	Fig. 1	Fig. 2	Fig. 3
x = 135 mm	<b>tk 51700-01</b>	<b>tk 51700-02</b>	<b>tk 51700-03</b>
	gezahnt, gerade serrated, straight droit, dentelés dentada, recta dentata, retta	gezahnt, rechts serrated, right dentelés, droites dentada, derecha dentata, destra	gezahnt, links serrated, left dentelés, gauche dentada, izquierda dentata, sinistra

Nasenpolypenzangen – Septumzangen | Pincas à polypes et la cloison nasale  
 Nasal polypus and septum forceps | Pinzas para pólipos y el tabique nasal  
 Pinze per polipi e setto nasale



WESTMACOTT  
 200 mm - 8" | **tk 51065-20**



LUBET-BARBON  
 200 mm - 8" | **tk 51066-20**



HARTMANN  
 160 mm - 6¼" | **tk 51067-16**  
 200 mm - 8" | **tk 51071-20**

Nasenpolypenzangen – Septumzangen  
*Nasal polypus and septum forceps*

Pinces à polypes et la cloison nasale  
*Pinzas para pólipos y el tabique nasal*  
Pinze per polipi e setto nasale

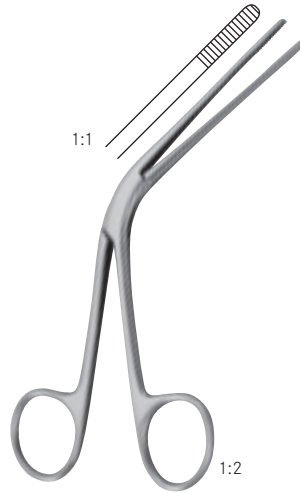

TILLEY

140mm - 5½"

**tk51068-14**

Nasentamponzange  
*Nasal dressing forceps*

Pince à pansement pour le nez  
*Pinza para tampones nasales*  
Pinza per tamponamento nasale

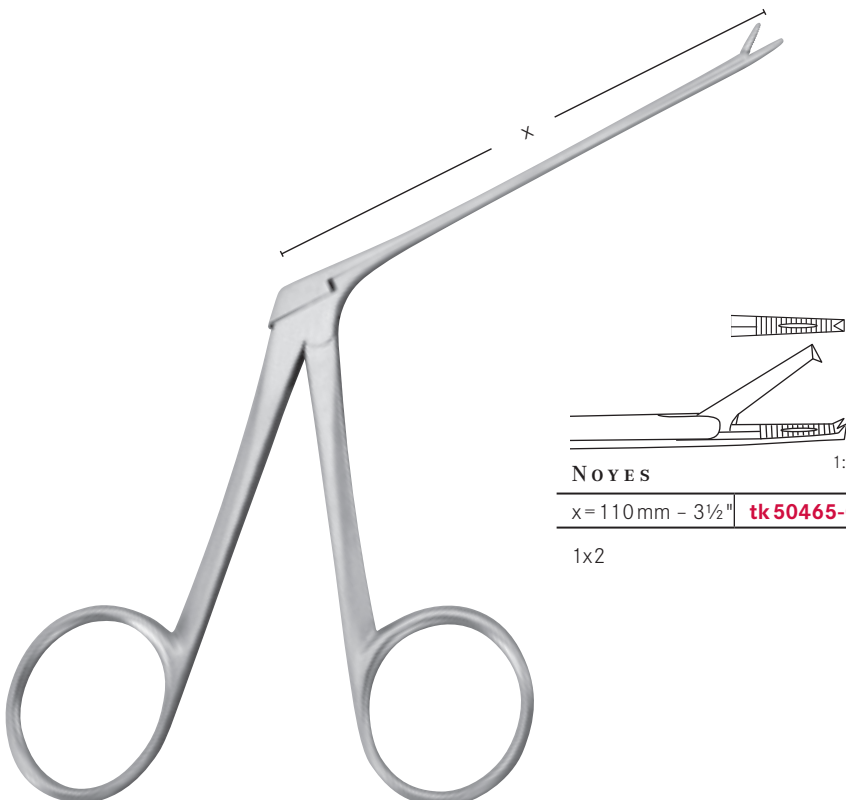

NOYES

x = 110mm - 3½"

**tk50465-09**

1x2

**Nasenpolypenzangen – Septumzangen** | Pincers à polypes et la cloison nasale  
*Nasal polypus and septum forceps* | Pinzas para pólipos y el tabique nasal  
 Pinze per polipi e setto nasale



**HEYMANN-KNIGHT**  
 180 mm - 7" | **tk 51069-18**





**CRAIG**  
 180 mm - 7" | **tk 51116-18**



**KNIGHT**  
 180 mm - 7" | **tk 51099-18**



**HEYMANN**

 1:1	 1:1	 1:1
180 mm - 7"   <b>tk 51095-01</b>	<b>tk 51095-02</b>	<b>tk 51095-03</b>

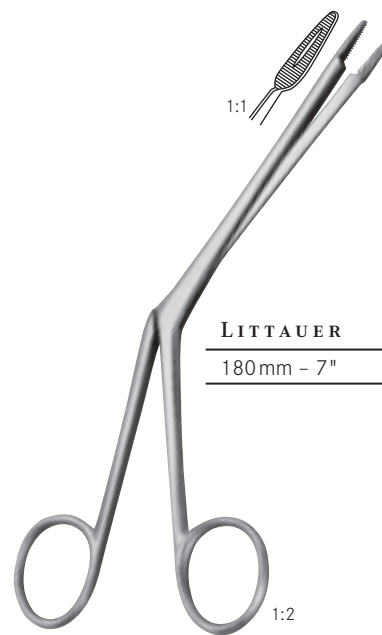

**LITTAUER**  
 180 mm - 7" | **tk 51079-18**

Septumzangen  
*Septum forceps*

Pinces pour la cloison nasale  
*Pinzas para el tabique nasal*  
Pinze per il setto nasale

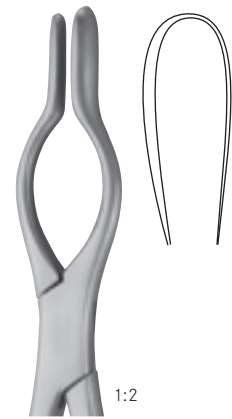
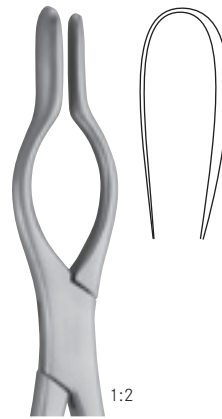

**COTTLE-WALSHAM**

230 mm - 9"

**tk 51695-01**

**tk 51695-02**

**tk 51695-03**

gerade  
*straight*

droit  
*recta*  
rette

links  
*left*

à gauche  
*izquierda*  
a sinistra

rechts  
*right*

à droite  
*derecha*  
a destra

Scharfe Nasenzangen  
*Nasal cutting forceps*

Pinces coupantes pour le nez  
*Pinzas nasales cortantes*  
 Pinze taglianti per naso

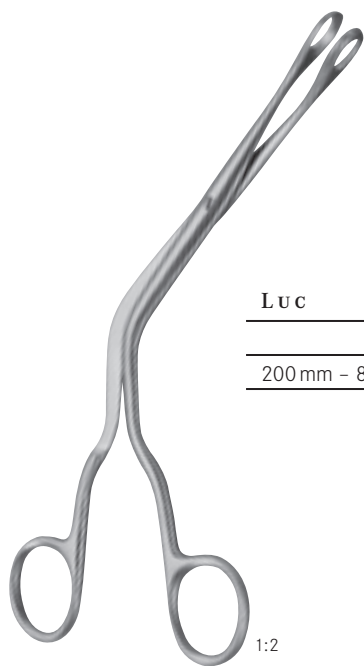

L u c	1:1		1:1	
	Fig. 1	Fig. 2	Fig. 1	Fig. 2
200 mm - 8"	<b>tk 51121-01</b>	<b>tk 51121-02</b>	<b>tk 51120-01</b>	<b>tk 51120-02</b>

gefenstert  
*fenestrated*  
 fenêtré  
*fenestrado*  
 finestrato

voll  
*full*  
 pleine  
*lleno*  
 pieno

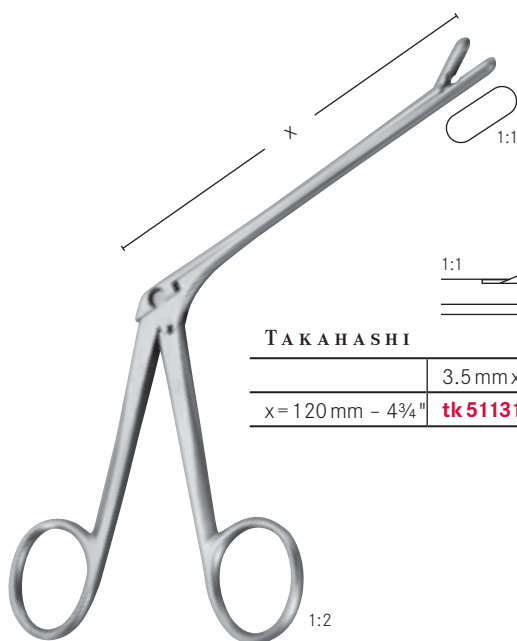

TAKAHASHI		
	3.5 mm x 10 mm	3.5 mm x 10 mm
x = 120 mm - 4¾"	<b>tk 51131-12</b>	<b>tk 51133-12</b>

Scharfe Nasenzangen  
*Nasal cutting forceps*

Pincès coupantes pour le nez  
*Pinzas nasales cortantes*  
Pinze taglianti per naso

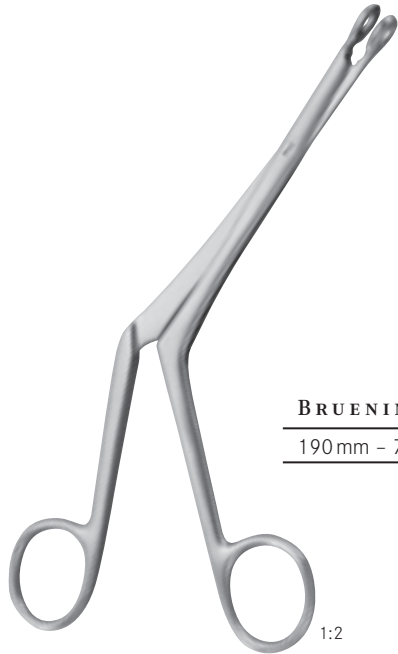

**BRUENINGS**

190 mm - 7½"



1:1



1:1



1:1



1:1

**tk 51123-01**

**tk 51123-02**

**tk 51123-03**

**tk 51123-04**

1:2

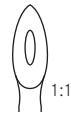
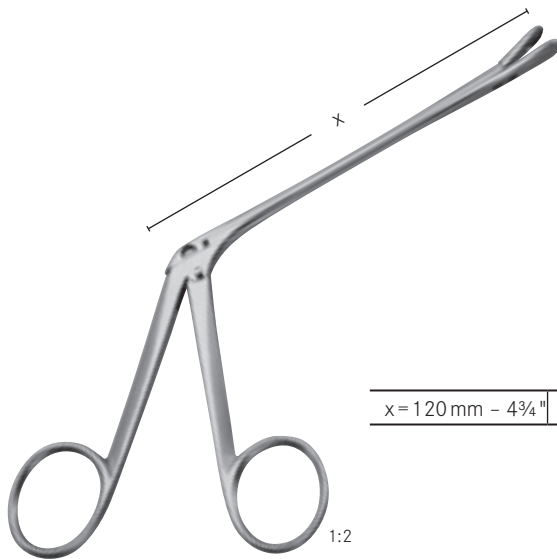

1:1

**WEIL**

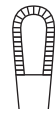

1:1

**WATSON-WILLIAMS**



1:1

x = 120 mm - 4¾"

**tk 51147-12**

**tk 51141-10**

**tk 51143-12**

1:2

Scharfe Nasenzangen  
*Nasal cutting forceps*

Pinces coupantes pour le nez  
*Pinzas nasales cortantes*  
 Pinze taglianti per naso

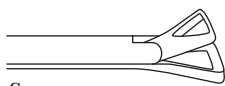

SCHMEDEN

x = 120 mm - 4 3/4"



1:1

tk51171-11

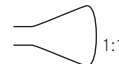

1:1

tk51171-12

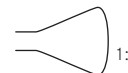

1:1

tk51171-13

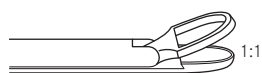

1:1

TOMATI

x = 120 mm - 4 3/4"

tk51173-12



1:1

STRUYCKEN

x = 120 mm - 4 3/4"

0.9 mm

1.2 mm

tk51174-01

tk51174-02



1:1

HENKE

x = 120 mm - 4 3/4"

tk51176-01

Scharfe Nasenzangen  
*Nasal cutting forceps*

Pincès coupantes pour le nez  
*Pinzas nasales cortantes*  
Pinze taglianti per naso



Fig. 10

Fig. 11

x = 115 mm - 4½'''

**tk 51729-00**

**tk 51729-01**

gerade  
*straight*  
droit  
*recta*  
retta



Fig. 12

Fig. 13

Fig. 14

1:1

x = 115 mm - 4½'''

**tk 51729-02**

**tk 51729-03**

**tk 51729-04**

aufgewinkelt  
*angeled up*  
angulée  
*angulada*  
angulata



Fig. 1

Fig. 2

x = 140 mm - 5½'''

**tk 51729-05**

**tk 51729-06**

feines Modell, gerade  
*delicate model, straight*  
modèle délicat, droit  
*modelo fino, recta*  
modelo fino, retta



Scharfe Nasenzangen  
*Nasal cutting forceps*

Pinces coupantes pour le nez  
*Pinzas nasales cortantes*  
 Pinze taglianti per naso

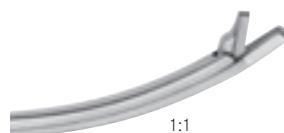

	Fig. 8
x = 140 mm - 5 1/2'''	<b>tk 51735-00</b>

	Fig.3
	<b>tk 51735-01</b>

aufgebogen  
*curved up*  
 courbe vers le haut  
*curve arriba*  
 curva in alto

feines Modell, aufgebogen  
*delicate model, curved up*  
 modèle délicat, courbe vers le haut  
*modelo fino, curve arriba*  
 modelo fino, curva in alto

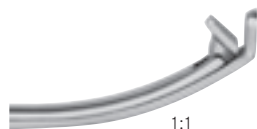

	Fig. 15
x = 140 mm - 5 1/2'''	<b>tk 51735-02</b>

feines Modell, aufgebogen und gewinkelt  
*delicate model, curved up and angled*  
 modèle délicat, courbe vers le haut et angulée  
*modelo fino, curve arriba y angulada*  
 modelo fino, curva in alto e angulata

Scharfe Nasenzangen  
*Nasal cutting forceps*

Pincès coupantes pour le nez  
*Pinzas nasales cortantes*  
Pinze taglianti per naso

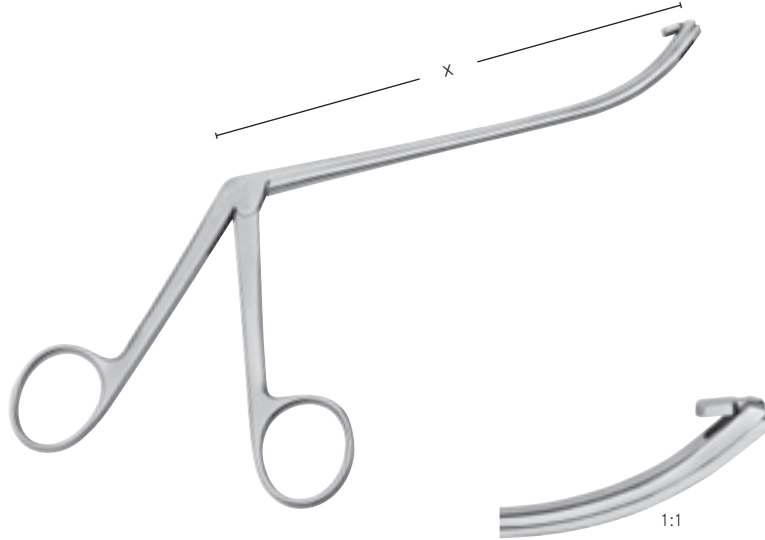

	Fig. 7
x = 140 mm - 5½"	<b>tk 51736-00</b>

rückwärts schneidend, aufgebogen  
*backward cutting, curved up*  
coupe retrograde, courbe vers le haut  
*corte retrogrado, curva arriba*  
corte indietro, curva in alto

Scharfe Nasenzangen  
Nasal cutting forceps

Pincas coupantes pour le nez  
Pinzas nasales cortantes  
Pinze taglianti per naso



	Fig. 4	Fig. 5
x = 140 mm - 5 1/2 mm	tk 51737-00	tk 51737-01

feines Modell  
*delicate model*  
modèle délicat,  
*modelo fino,*  
modelo fino,

gerade  
*straight*  
droit  
*recta*  
retta

aufgewinkelt  
*angled*  
angulée  
*angulada*  
angulata

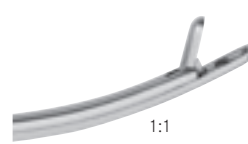
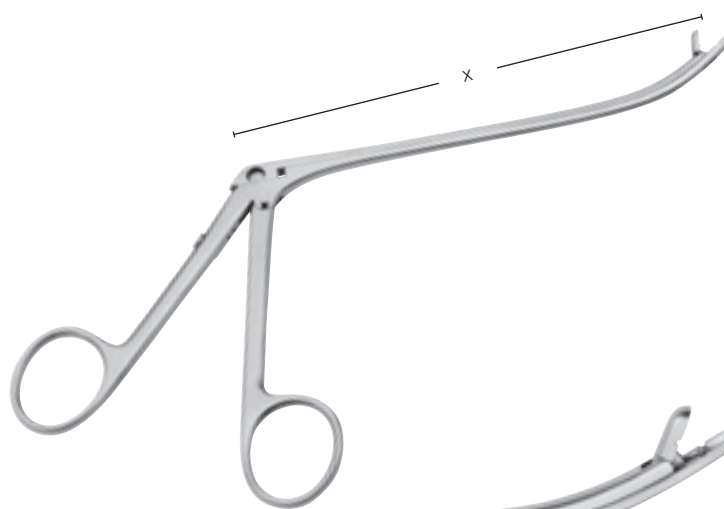

	Fig. 9	Fig. 6
x = 140 mm - 5 1/2 mm	tk 51737-02	tk 51737-03

Standard, aufgebogen  
*standard model, upcurved*  
modèle standard, angulée  
*modelo estandar, angulada*  
modelo standsrd, angulata

feines Modell, aufgebogen  
*delicate model, upcurved*  
modèle délicat, courbe vers le haut  
*modelo fino, curve arriba*  
modelo fino, curva in alto

**Scharfe Nasenzangen**  
*Nasal cutting forceps*

Pincès coupantes pour le nez  
*Pinzas nasales cortantes*  
Pinze taglianti per naso

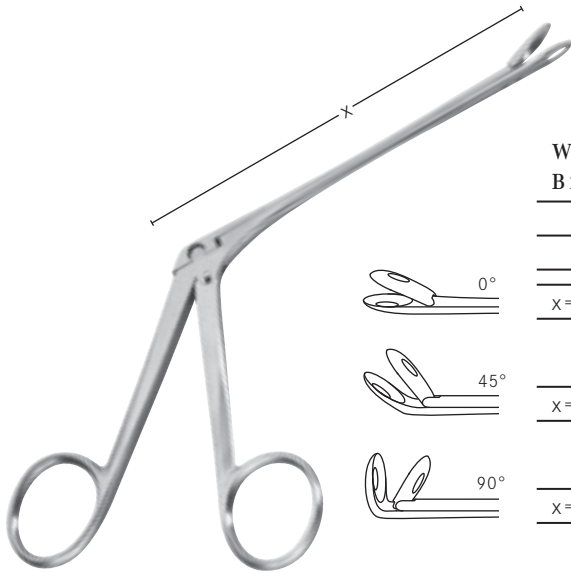

WEIL- BLAKESLEY	a				
	Fig. 1	Fig. 2	Fig. 3	Fig. 4	Fig. 5
	a = 3.0 mm	a = 3.5 mm	a = 4.5 mm	a = 5.0 mm	a = 5.5 mm
x = 120 mm - 4¾"	<b>tk 51155-01</b>	<b>tk 51155-02</b>	<b>tk 51155-03</b>	<b>tk 51155-04</b>	<b>tk 51155-05</b>

x = 120 mm - 4¾"	<b>tk 51158-01</b>	<b>tk 51158-02</b>	<b>tk 51158-03</b>	<b>tk 51158-04</b>	
x = 120 mm - 4¾"	<b>tk 51159-01</b>	<b>tk 51159-02</b>	<b>tk 51159-03</b>		

	Fig. 1	Fig. 2	Fig. 3	Fig. 4	Fig. 5
	a = 3.0 mm	a = 3.5 mm	a = 4.5 mm	a = 5.0 mm	a = 5.5 mm
x = 180 mm - 7"	<b>tk 51160-01</b>	<b>tk 51160-02</b>	<b>tk 51160-03</b>	<b>tk 51160-04</b>	<b>tk 51160-05</b>

x = 180 mm - 7"	<b>tk 51161-01</b>	<b>tk 51161-02</b>	<b>tk 51161-03</b>	<b>tk 51161-04</b>	
-----------------	--------------------	--------------------	--------------------	--------------------	--

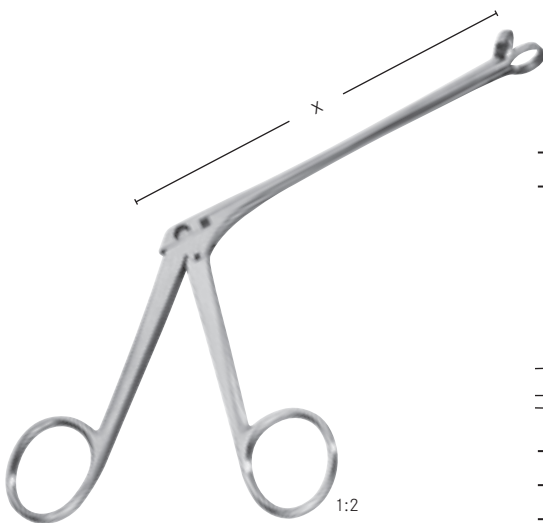

HARTMANN	a			
	Fig. 1	Fig. 2	Fig. 3	Fig. 4
x = 120 mm - 4¾"	<b>tk 51165-01</b>	<b>tk 51165-02</b>	<b>tk 51165-03</b>	<b>tk 51165-04</b>

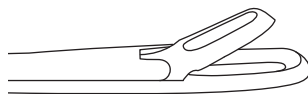

MYLES	Fig. 1	Fig. 2	Fig. 3
		2.0x10.0 mm	2.5x12.0 mm
x = 120 mm - 4¾"	<b>tk 51162-01</b>	<b>tk 51162-02</b>	<b>tk 51162-03</b>

Durchschneidende Nasenzangen  
*Nasal through cutting forceps*

Pinces coupantes pour le nez  
*Pinzas nasales cortantes*  
 Pinze taglianti per naso



	x=130 mm	x=130 mm	x=130 mm	x=130 mm
a = 2.5 mm	<b>tk 51156-01</b>	<b>tk 51156-21</b>	<b>tk 51156-04</b>	<b>tk 51156-24</b>
a = 3.5 mm	<b>tk 51156-02</b>	<b>tk 51156-22</b>	<b>tk 51156-05</b>	<b>tk 51156-25</b>
a = 4.0 mm	<b>tk 51156-03</b>	<b>tk 51156-23</b>	<b>tk 51156-06</b>	<b>tk 51156-26</b>

Maul	gerade	gerade, gezahnt	45° aufwärts	45° aufwärts, gezahnt
Jaw	straight	straight, serrated	45° upwards	45° upwards, serrated
Mors	droit	droit, dentelé	45° vers le haut	45° vers le haut, dentelé
Boca	recta	recta, dentada	45° arriba	45° arriba, dentada
Morso	retta	retta, dentata	45° verso l'alto	45° verso l'alto, dentata

**Nasenmesser** | **Bistouris pour nez**  
**Nasal knives** | **Cuchillos nasales**  
**Bisturi per naso**

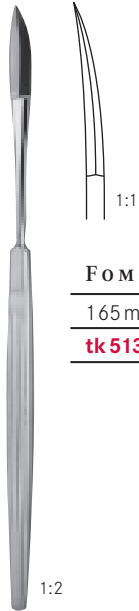

**FOMON**

165 mm - 6½"

**tk 51300-16**

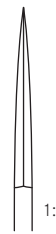
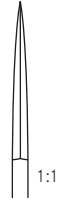

**JOSEPH**

160 mm - 6¼"

Fig. 1

Fig. 2

Fig. 1

Fig. 2

**tk 51302-01**

**tk 51302-02**

**tk 51303-01**

**tk 51303-02**

scharf/spitz      gerade  
*sharp/sharp*      *straight*  
tranchant/pointu      droit  
*cortante/agudo*      *recta*  
acuto      retto

gebogen  
*curved*  
courbe  
*curva*  
curvo



**JOSEPH**

140 mm - 5½"

**tk 51306-15**

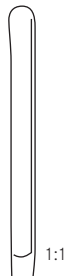

**COTTLE**

150 mm - 6"

**tk 51308-15**

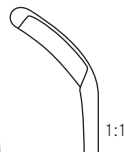

**JOSEPH**

175 mm - 7"

**tk 51335-03**



**BRUENINGS**

165 mm - 6½"

**tk 51310-00**

**tk 51310-01**

Ersatzklinge  
*Spare blade*  
Lame de rechange  
*Hoja de recambio*  
Lama di ricambio

Nasenmesser  
Nasal knives

Bistouris pour nez  
Cuchillos nasales  
Bisturi per naso



1:2

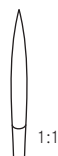

1:1

**GERZOG**

160mm - 6¼"

**tk 50712-16**



1:1

**BUCK**

160mm - 6¼"

**tk 50714-16**



1:2

1:1

**CONVERSE**

160mm - 6¼"

**tk 51355-01**



1:2



1:2

**FREER**

190mm - 6½"

**tk 51350-01**

**tk 51350-02**



1:2

1:1

**FREER**

150mm - 6"

**tk 51342-12**



1:2

1:1

**FREER**

150mm - 6"

**tk 51344-15**



1:2

1:1

**FREER**

150mm - 6"

**tk 51346-15**

Nasenhäkchen  
*Nasal hooks*

Crochets nasales  
*Ganchitos nasales*  
Uncini nasali

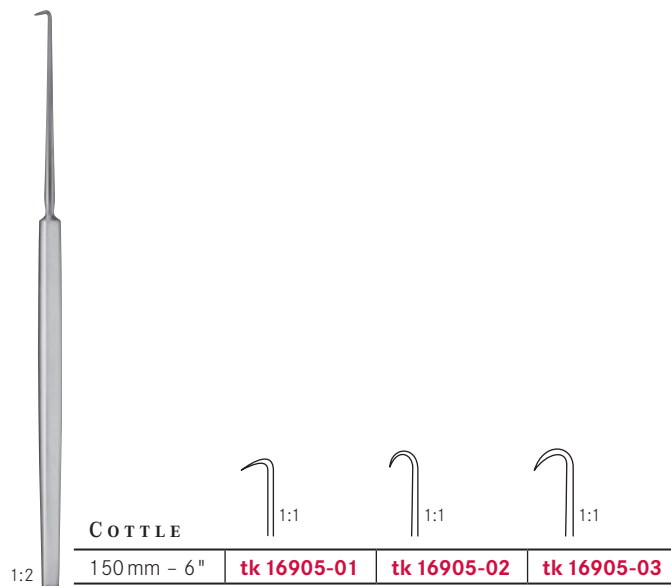
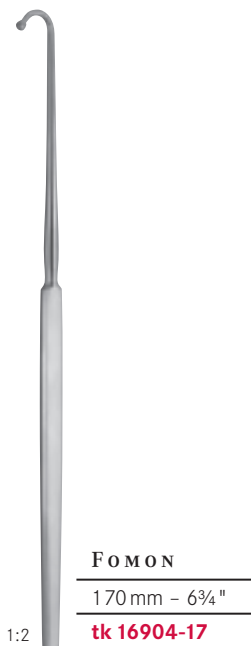



Nasenhäkchen  
Nasal hooks

Crochets nasales  
Ganchitos nasales  
Uncini nasali

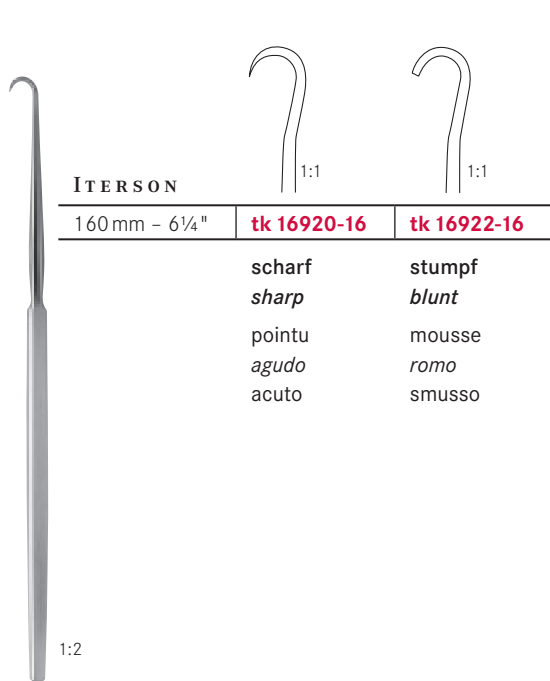

**ITERSON**

160 mm - 6¼"	<b>tk 16920-16</b>	<b>tk 16922-16</b>
	scharf sharp pointu agudo acuto	stumpf blunt mousse romo smusso

1:2

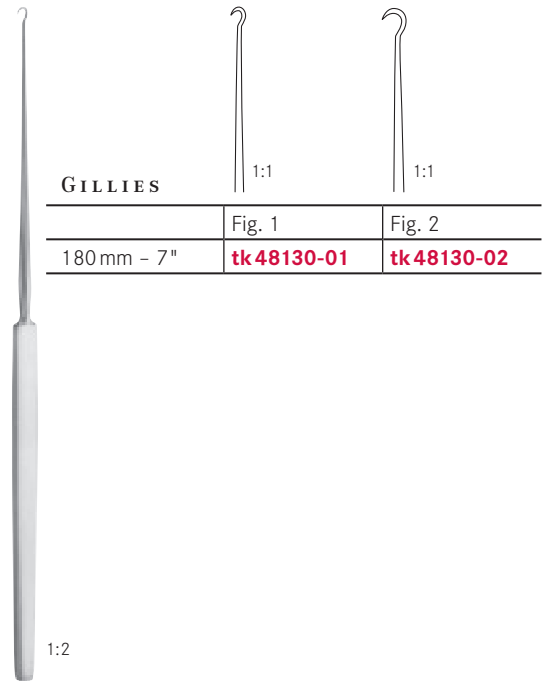

**GILLIES**

	Fig. 1	Fig. 2
180 mm - 7"	<b>tk 48130-01</b>	<b>tk 48130-02</b>

1:2

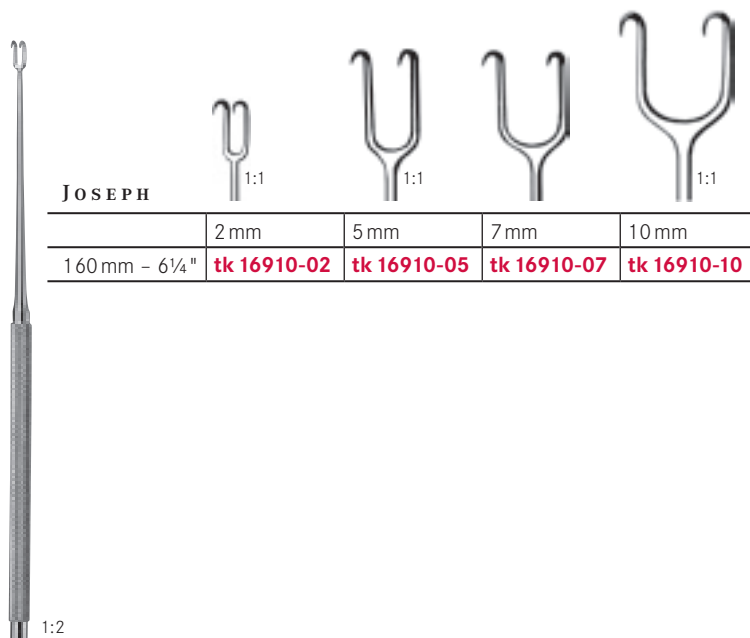

**JOSEPH**

	2 mm	5 mm	7 mm	10 mm
160 mm - 6¼"	<b>tk 16910-02</b>	<b>tk 16910-05</b>	<b>tk 16910-07</b>	<b>tk 16910-10</b>

1:2

Nasenhäkchen | Crochets nasales  
Nasal hooks | Ganchitos nasales  
Uncini nasali



**COTTLE-  
NEIVERT**

200 mm - 8"

**tk 16912-20**

1:2



**FOMON**

160 mm - 6¼"

**tk 16914-16**

1:2



**COTTLE**

150 mm - 6"



1:1

**tk 16915-01**

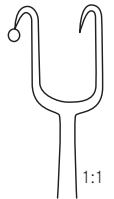

1:1

**tk 16915-02**



1:1

**tk 16915-03**

1:2



**NEIVERT**

160 mm - 6¼"

**tk 16916-16**

1:2

Nasen- und Trachealhäkchen  
Trachea and nose retractors

Ecarteurs nasales et tracheales  
Separadores traqueales y nasales  
Uncini tracheali e nasali



COTTLE

150 mm - 6"

tk 16917-15

tk 16918-15

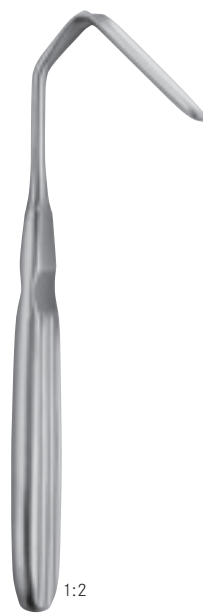

AUFRICHT

190 mm - 6 1/4"

tk 16906-19



KILNER

100 mm - 4"

tk 16907-10



CONVERSE

120 mm - 4 3/4"

tk 16908-12



LUKENS

170 mm - 6 2/5"

tk 16933-17

stumpf  
blunt

mousse  
romo  
smusso

1:2



JACSON

150 mm - 6"

tk 16930-15

1:2



AUFRICHT

tk 17919-13

Nasenhaken  
Nasal hook

Crochet pour le nez  
Gancho para la nariz  
Uncino nasale



COTTLE

tk 17750-00

Daumenhaken  
Thumb hook

Crochet pour le doigt  
Gancho para el dedo  
Uncino da fissare sul pollice

Ringmesser  
*Adenoid curettes*

Couteaux à végétations adénoïdes  
*Cuchillos para vegetaciones adenoides*  
Adenotomi

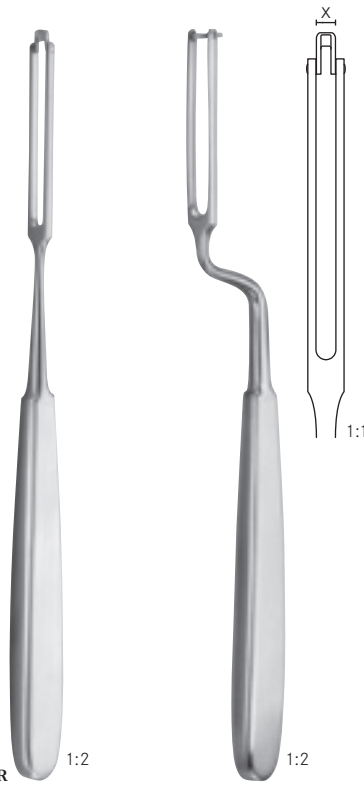

**BALLENGER**

	200 mm - 8"	200 mm - 8"
x = 3 mm	<b>tk 51410-03</b>	<b>tk 51411-03</b>
x = 4 mm	<b>tk 51410-04</b>	<b>tk 51411-04</b>
x = 5 mm	<b>tk 51410-05</b>	<b>tk 51411-05</b>

gerade  
*straight*

droit  
*recto*  
rette

bajonett  
*bayonet*

baionette  
*bayoneta*  
baionetta

Nasenpolypenschnürer  
*Nasal polypus snares*

Serre noeuds pour polypes  
*Polipótomos nasales*  
 Serranodi nasali



0.3 mm Ø x 100 mm **tk 50320-30**

in Bündeln mit 12 Stück  
*in bundles of 12 pieces*

en paquets de 12 pièces  
*en liós de 12 piezas*  
 pacchetto di 12 pezzi



**KRAUSE**

260 mm - 10¼" **tk 50323-26**



**KRAUSE-VOSS**

260 mm - 10¼" **tk 50325-26**

mit 2 Aufsätzen  
*with 2 inserts*

avec 2 guide-anses  
*con 2 guias*  
 con 2 guide ansa



**LANGE-WILDE**

240 mm - 9½" **tk 50328-24**

**Flexibler Spannarm**  
*Flexible tension arm*

**Bras flexible**  
*Brazo flejible*  
**Braccio flessibile**

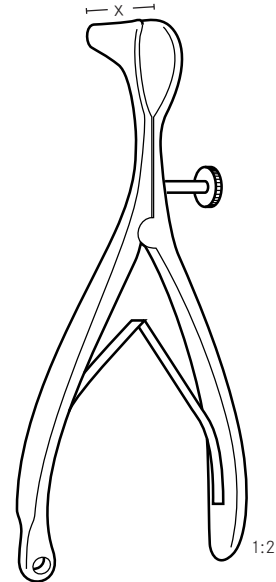

**COTTLE-MASING**

	140 mm - 5½"
x = 35 mm	<b>tk 50837-35</b>
x = 50 mm	<b>tk 50837-50</b>
x = 75 mm	<b>tk 50837-75</b>
x = 90 mm	<b>tk 50837-90</b>

**Nasenseptumspekulum mit Stellschraube für flexibler Spannarm**  
*Nasal septum speculum, With Set Screw for flexible tension arm*

*Spéculum pour la cloison nasale, pour tendeur flexible*  
*Especulo para el septo nasal, para brazo flejible*  
*Specolo per il setto nasale, per braccio flessibile*

**tk 50029-00**

**Flexibler Spannarm mit Befestigungsstange für OP-Tische**  
*Flexible tension arm with holding rod for OP-tables*

*Tendeur flexible avec tige pour tables d'opérations*  
*Brazo flejible con tija para mesas de operaciones*  
*Braccio flessibile con morsetto per tavoli operatore*

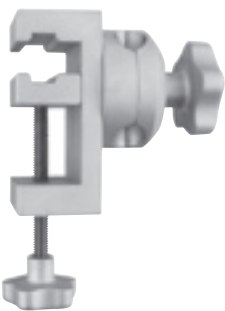

**tk 50029-01**

**Drehbare Halterung für flexiblen Spannarm**  
*Rotatable holder for flexible tension arm*

*Support rotatif pour tendeur flexible*  
*Soporte giratorio para brazo flejible*  
*Supporto rotante per braccio flessibile*



**tk 50029-03**

**Endoskophalterung**  
*Endoscope holder*

*Support pour optiques*  
*Soporte para opticas*  
*Supporto per ottiche*

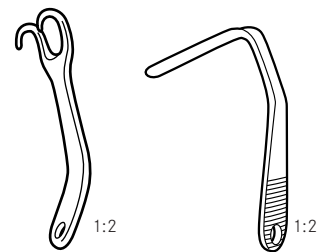

**AUFRICHT**

62 mm - 2½"	59 mm - 2¼"
<b>tk 16906-01</b>	<b>tk 16906-02</b>

**Haken für flexiblen Spannarm**  
*Hooks for flexible tension arm*

*Crochets pour tendeur flexible*  
*Ganchos para brazo flejible*  
*Uncini per braccio flessibile*

Nasenspiegel  
*Nasal mirror*

Miroir nasal  
*Espejo nasal*  
Specchio nasale

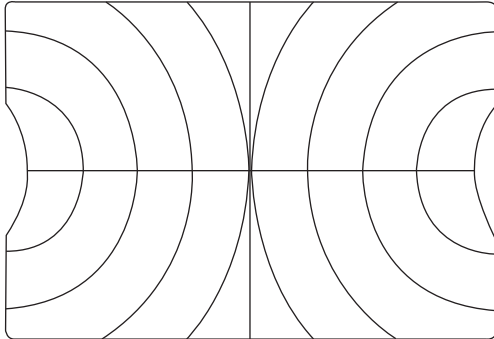

**GLATZEL**

200 x 130 mm

**tk 50870-00**

Nasenspiegel

*Nasal mirror*

Miroir nasal

*Espejo nasal*

Specchio nasale

Pulverbläser  
*Atomizer*

Pulvérisateur  
*Pulverizador*  
Soffiatori



**UNIVERSAL**

**tk 50924-00**

Pulverbläser, komplett mit beweglicher Düse, Flasche 30 ccm

*Atomizer, complete with movable tube, bottle 30 ccm*

Pulvérisateur, complet avec tuyère mobile, flacon 30 ccm

*Pulverizador, completo con tubo móvil, botella 30 ccm*

Soffiatore, completo con ugello mobile, bottiglia 30 ccm

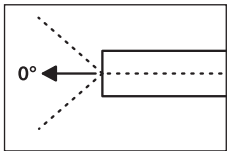
**Naso-Pharyngoskope  
Naso-pharyngoscopes**
**Nasopharyngoscopes  
Nasofaringoscopios flexibles  
Nasofaringoscopio flessibile**

Konventionelles Bildbündel, mit 2-fach Abwinkelung (160°), Einhandbedienung, einlegbar und gassterilisierbar  
*Conventional bundle, 2-way deflection (160°), one-hand control, soakable, gas-sterilization.*

Localisation conventionnelle, dirigable en 2 directions (160°). Commande avec 1 main, sterilisable à froide ou à gaz  
*Transmisión a fibra optica, dirigible en 2 direcciones (160°), manejable con 1 mano, sumergible, esterilizable a gas*  
 Fascio di fibre convenzionale, doppia angolazione (160°), controllabile con una sola mano, sterilizzabile a gas, immergibile

Ø 3.2 mm – 300 mm	20 mm	3 mm – 60 mm	8000	<b>tk 700-269</b>
Ø, Arbeitslänge	Länge d. abwinkelbaren Spitze	Tiefenschärfe	Pixel	
Ø, Working length	Length of movable tip section	Depth of focus	Pixel	
Ø, Longueur de travail	Longueur du tip mobil	Profondeur de champ	Pixel	
Ø, Longitud de trabajo	Longitud de la punta movil	Profundidad de campo	Pixel	
Ø, Lunghezza operativa	Lunghezza della punta mobile	Profondità di campo	Pixel	

Konventionelles Bildbündel, Abwinkelung (140°), Instrumentenkanal, Einhandbedinung ,einlegbar und gassterilisierbar  
*Conventional bundle, deflection (140°), instrument channel, one-hand control, soakable, gas-sterilization.*

Localisation conventionnelle, dirigable (140°). canal d'instrument, commande avec 1 main, sterilisable à froide ou à gaz  
*Transmisión a fibra optica, dirigible (140°), canal para instrumentos, manejable con 1 mano, sumergible, esterilizable a gas*  
 Fascio di fibre convenzionale, angolazione (140°), canale operativo, controllabile con una sola mano, sterilizzabile a gas, immergibile

Ø 4.3 mm – 400 mm	Ø 1.4 mm	3 mm – ∞	7800	<b>tk 700-267</b>
Ø, Arbeitslänge	Instrumentenkanal	Tiefenschärfe	Pixel	
Ø, Working length	Instrument channel	Depth of focus	Pixel	
Ø, Longueur de travail	Canal d'instrument	Profondeur de champ	Pixel	
Ø, Longitud de trabajo	Canal para instrumentos	Profundidad de campo	Pixel	
Ø, Lunghezza operativa	Canale operativo	Profondità di campo	Pixel	



Auf Wunsch ist das Naso-Pharyngoskop mit einer Linkshänderbedienung erhältlich.  
*If required, the naso-pharyngoscope is available for left-hand use.*  
 Sur demande, également disponible pour gauchers  
 Para zurdos disponible sobre demanda  
 Su richiesta il nasofaringoscopio è disponibile per mancini

