

Rhinoplastik | Rhinoplastique
Rhinoplasty | *Rinoplastica*
Rinoplastica



Nasensägen | Scies nasales
Nasal saws | *Sierras nasales*
Seghe nasali



JOSEPH
190 mm - 7½" | 190 mm - 7½"
tk 51661-01 | **tk 51661-02**



JOSEPH
190 mm - 7½"
tk 51661-03

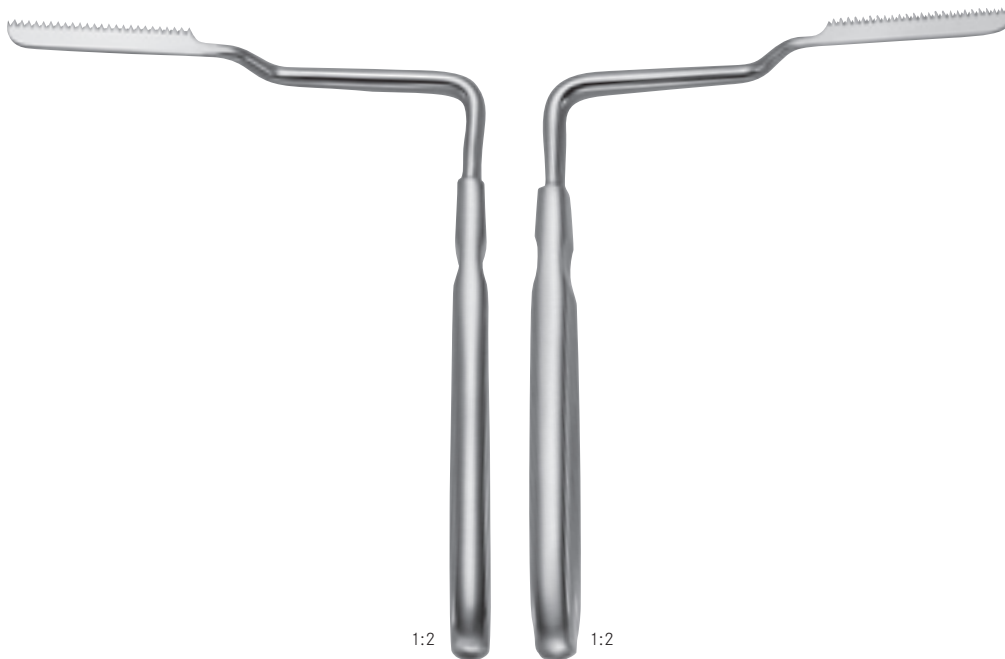

JOSEPH
170 mm - 6¾" | 170 mm - 6¾"
tk 51655-20 | **tk 51657-20**

Nasenraspeln | Râpes nasales
Nasal rasps | *Limas nasales*
 Raspe nasali

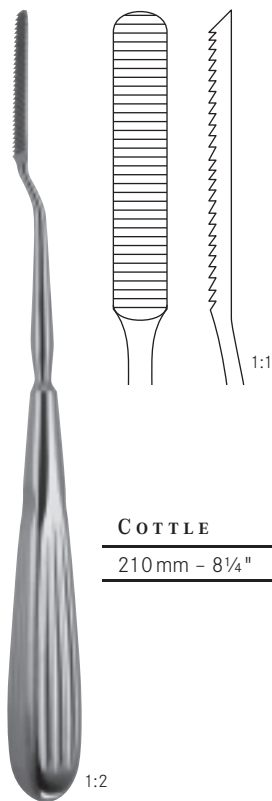

COTTLE

210 mm - 8¼"	tk 51665-21
--------------	--------------------

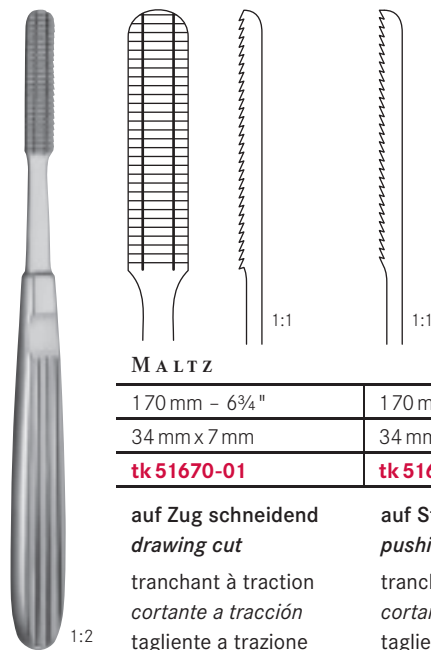

MALTZ

170 mm - 6¾"	170 mm - 6¾"
34 mm x 7 mm	34 mm x 7 mm
tk 51670-01	tk 51670-02

auf Zug schneidend
drawing cut
 tranchant à traction
cortante a tracción
 tagliente a trazione

auf Stoss schneidend
pushing cut
 tranchant en poussant
cortante a empuje
 tagliente a urto



AUFRICHT

210 mm - 8¼"	tk 51672-21
--------------	--------------------

auf Zug und auf Stoss schneidend
drawing and pushing cut
 tranchant à traction et en poussant
cortante a tracción y empuje
 tagliente a trazione e a urto

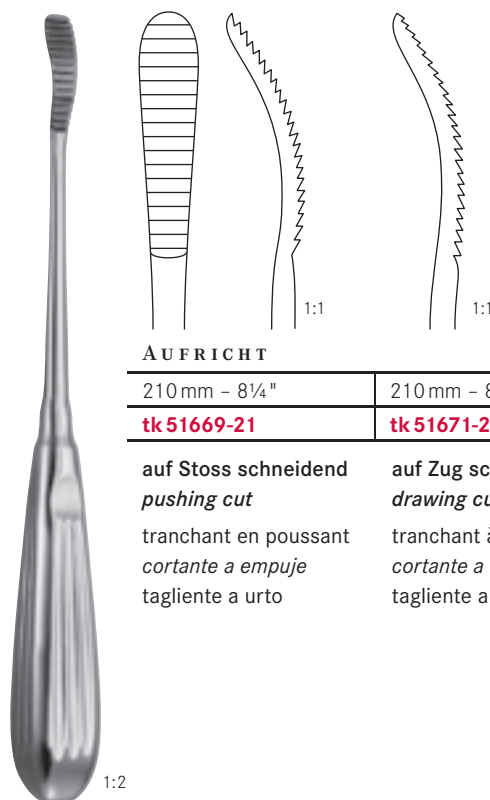

AUFRICHT

210 mm - 8¼"	210 mm - 8¼"
tk 51669-21	tk 51671-21

auf Stoss schneidend
pushing cut
 tranchant en poussant
cortante a empuje
 tagliente a urto

auf Zug schneidend
drawing cut
 tranchant à traction
cortante a tracción
 tagliente a trazione

Nasenraspeln
Nasal rasps

Râpes nasales
Limas nasales
Raspe nasali

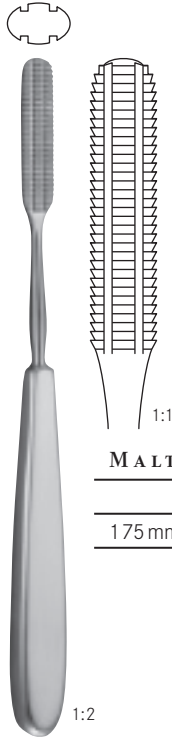

MALTZ

	40 mm x 9 mm
175 mm - 7"	tk 51663-18



WIENER

	Ø 3.5 mm	Ø 3.5 mm
180 mm - 7"	tk 51675-18	tk 51677-18

Antrum Raspeln
Antrum rasps

Râpes pour le fosse nasale
Limas para el antrum
Raspe per antrum

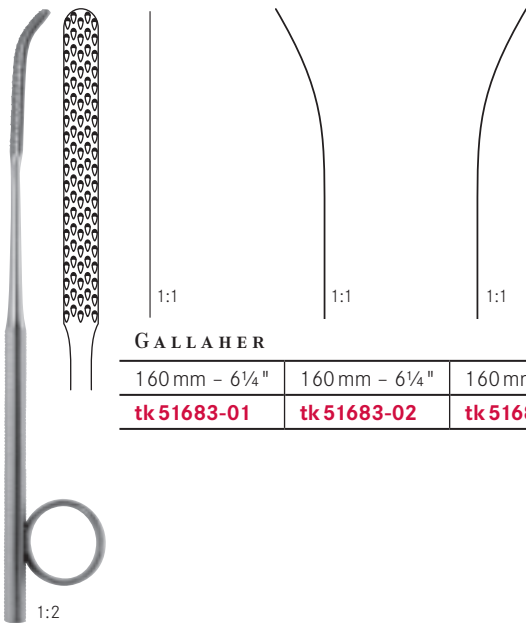

GALLAHER

160 mm - 6¼"	160 mm - 6¼"	160 mm - 6¼"
tk 51683-01	tk 51683-02	tk 51683-03

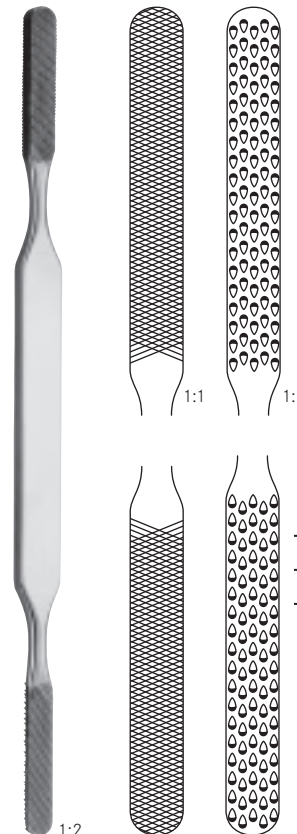

FOMON

210 mm - 8¼"
tk 51685-21

Raspeln mit Hartmetall
Rasps with tungsten carbide

Râpes avec inserts de carbure de tungstène
Limas con carburo de tungsteno
Raspe con tungsteno

TUCAR^{TK}

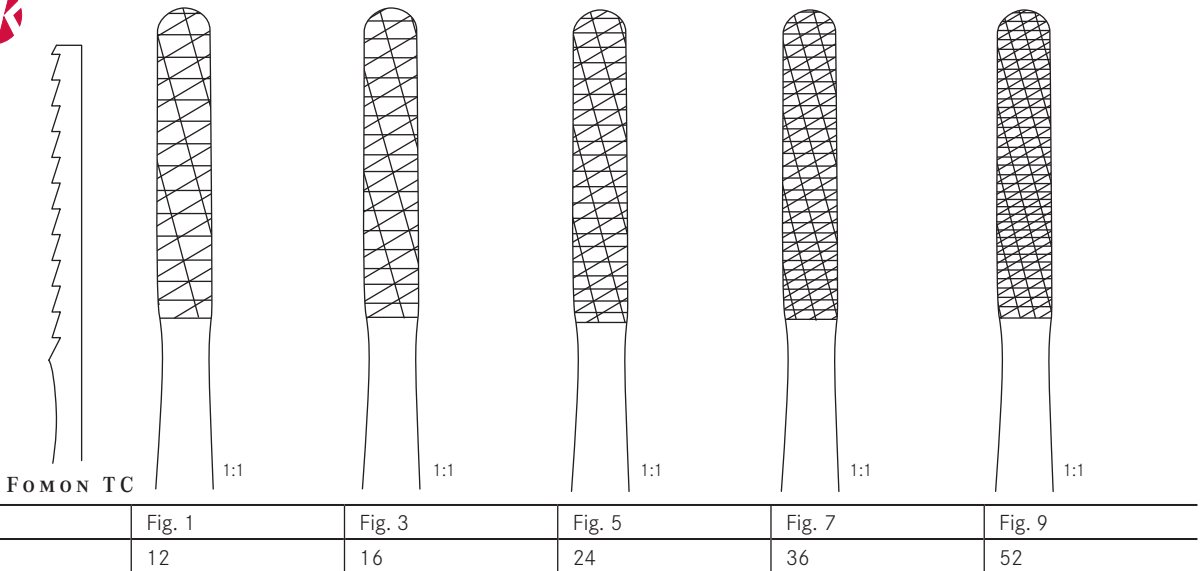

Zähne
Teeth
Dentes
Dientes
Denti

200 mm - 8"	tk 51686-01 TC	tk 51686-03 TC	tk 51686-05 TC	tk 51686-07 TC	tk 51686-09 TC
-------------	----------------	----------------	----------------	----------------	----------------

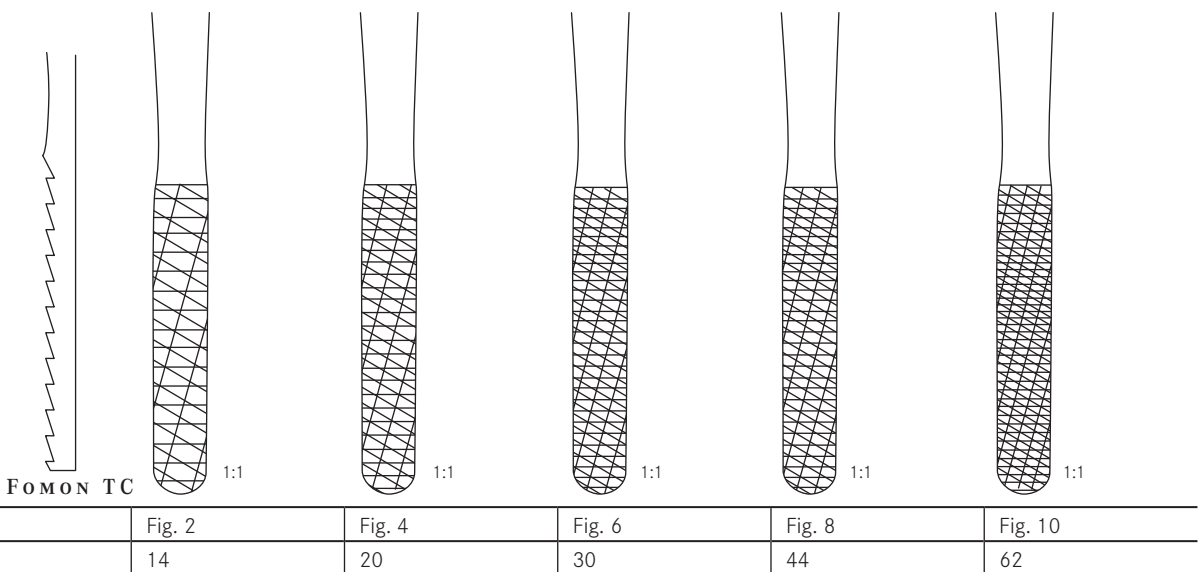

Zähne
Teeth
Dentes
Dientes
Denti

1:1

Septuminstrumente
Septum instruments

Instruments pour la cloison nasal
Instrumentos para el tabique nasal
Strumenti per il setto nasale



1:2

BRUENINGS-BRUNK

190 mm - 7½"	tk 16955-19
--------------	--------------------

Kieferhöhlenhaken, gezahnt
Antrum retractor, serrated

Ecarteur pour sinus maxillaire, dentelé
Separador para sinus, dentado
Retrattore mascellare, dentato



1:2

RITTER-HALLE

	160 mm - 6¼"
2.5 mm Ø	tk 6376-25
3.0 mm Ø	tk 6376-30
4.0 mm Ø	tk 6376-40

Stirnhöhlen-Dilatatore
Frontal sinus bougies

Dilatateurs pour le sinus frontal
Dilatadores para el sinus frontal
Dilatatore per il seno frontale

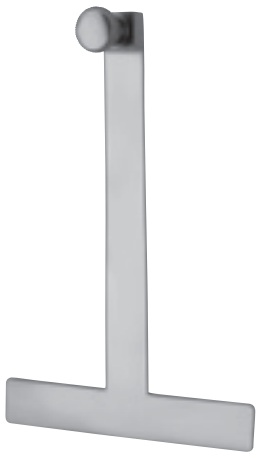

1:2

COTTLE

120 mm - 4¾"	tk 51647-01
--------------	--------------------

Griff
Handle

Manche
Mango
Manico



1:2

COTTLE

7 mm	tk 51647-02
------	--------------------

Führungshilfe für Osteotome
Guide support for osteotomes

Support conducteur pour ostéotomes
Soporte de guía para osteótomos
Supporto di guida per osteotomi



1:2

COTTLE

65 mm x 30 mm x 30 mm	tk 51648-00
-----------------------	--------------------

Knorpelquetsche
Cartilage crusher

Pinces-gouge à cartilage
Machacadora
Torchio per cartilagine



1:2

Septumzangen
Septum forceps

Pinces pour la cloison nasale
Pinzas para el tabique nasal
Pinze per il setto nasale

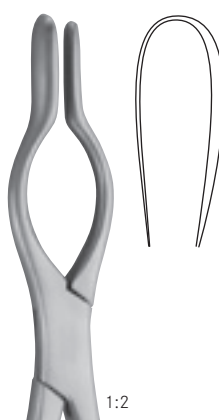
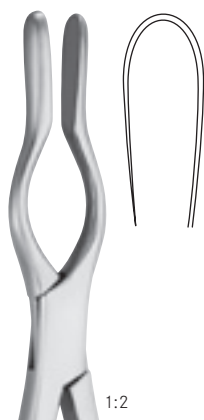

COTTLE-WALSHAM

230mm - 9"

tk 51695-01

tk 51695-02

tk 51695-03

gerade
straight
droit
recta
rette

links
left
à gauche
izquierda
a sinistra

rechts
right
à droite
derecha
a destra

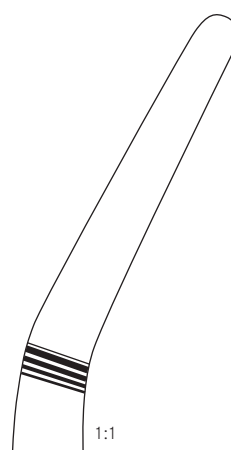
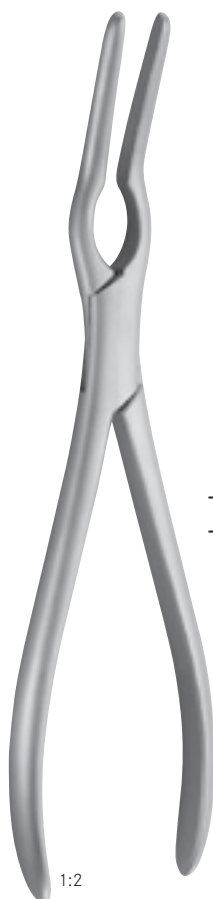

ASCH

230mm - 9"

tk 51697-23

Septumzangen
Septum forceps

Pinces pour la cloison nasale
Pinzas para el tabique nasal
Pinze per il setto nasale



1:1

MIDDLETON-JANSEN

190 mm - 7½"

tk51180-19



1:1

MIDDLETON-JANSEN

190 mm - 7½"

tk51182-19

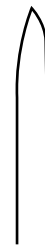
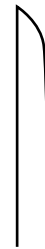

OBWEGESER

230 mm - 8¼"

tk51264-01

tk51264-02

tk51264-03

Nasenrückenschere, gezahnt
Nasal bridge scissors, serrated

Ciseaux pour le dos nasal, dentelé
Tijera para dorso nasal, dentada
Forbice per dorso nasale, dentellate

Septumzangen
Septum forceps

Pinces pour la cloison nasale
Pinzas para el tabique nasal
Pinze per il setto nasale



1:2

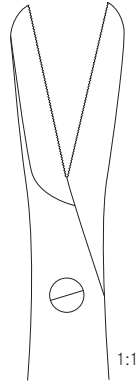

1:1

CAPLAN

200mm - 8"

tk51184-20

gezahnt
toothed
dentelée
dentado
dentato



1:2

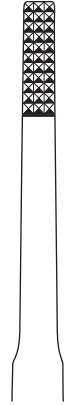

1:1

RUBIN

210mm - 8¼"

tk51188-21



tk51188-01

Schutzkappe
Protection Cap
Capuchon protecteur
Caperuza protectora
Calotta protettiva



1:2

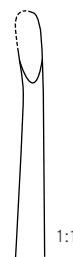

1:1



1:1



1:1

OBWEGESER

220mm - 8¾"

tk51179-04

tk51179-06

tk51179-08

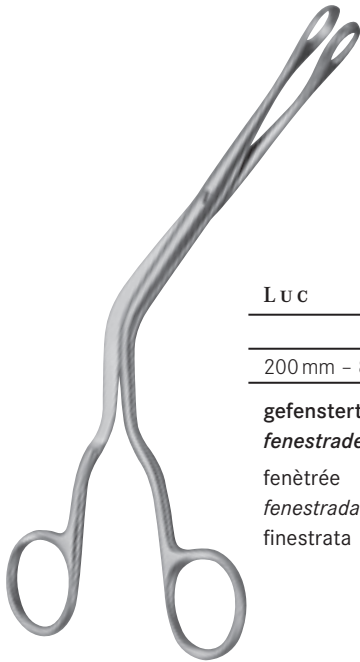

Scharfe Nasenzangen
Nasal cutting forceps

Pincès coupantes pour le nez
Pinzas nasales cortantes
Pinze taglianti per naso

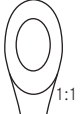
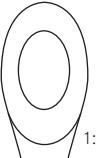





L u c	 1:1	 1:1
	Fig. 1	Fig. 2
200 mm - 8"	tk 51121-01	tk 51121-02

gefenstert
fenestrated
fenêtrée
fenestrada
finestrata

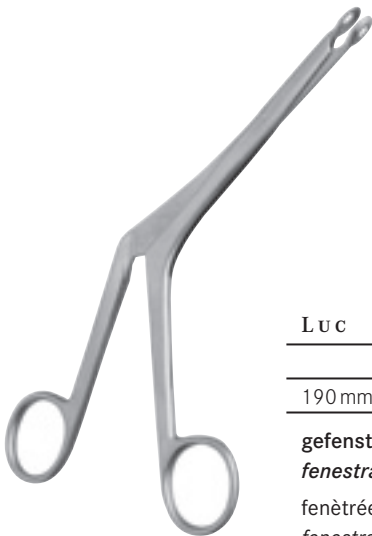
L u c	 1:1	 1:1
	Fig. 1	Fig. 2
200 mm - 8"	tk 51120-01	tk 51120-02

voll
full
pleine
lleno
pieno



L u c	 1:1	 1:1	 1:1
	Fig. 1	Fig. 2	Fig. 3
190 mm - 7½"	tk 51124-01	tk 51124-02	tk 51124-03

gefenstert
fenestrated
fenêtrée
fenestrada
finestrata

Antrumküretten
Antrum curettes

Curettes d'antrum
Curetas para el antrum
Curette per antrum



1:2



1:1



1:1

200 mm - 8"	200 mm - 8"
tk 50621-04	tk 50621-05



1:2



1:1

200 mm - 8"
7 mm x 11 mm
tk 50621-01



1:2



1:1

PRATT

210 mm - 8¼"
tk 50621-22



1:2



1:1

FAULKNER

210 mm - 8¼"
tk 51364-21

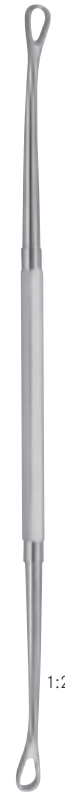

1:2



1:1

COAKLEY

200 mm - 8"
tk 51368-12



1:2

COAKLEY



1:1



1:1



1:1



1:1



1:1



1:1

	Fig. 1	Fig. 2	Fig. 3	Fig. 4	Fig. 5	Fig. 6
170 mm - 6¾"	tk 51366-01	tk 51366-02	tk 51366-03	tk 51366-04	tk 51366-05	tk 51366-06
tk 51366-00	x	x	x	x	x	x

Satz
Set
Jeu
Juego
Serie

Septumelevatorien – Raspatorien
Septum elevators – raspatories

Elevateurs – rugines pour la cloison nasale
Elevadores – leguas para el tabique nasal
Elevatori – periostotomi per setto

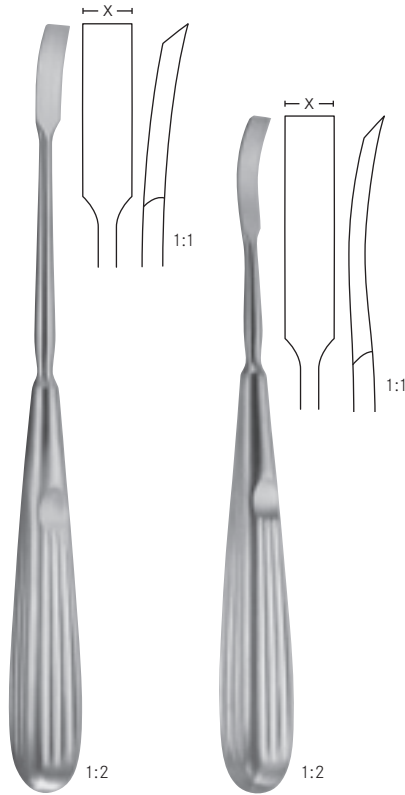

LEMPERT

	205 mm – 8"	180 mm – 7"
x = 6 mm	tk 50787-20	tk 50789-17



FREER

	x = 4 mm
160 mm – 6¼"	tk 50770-16

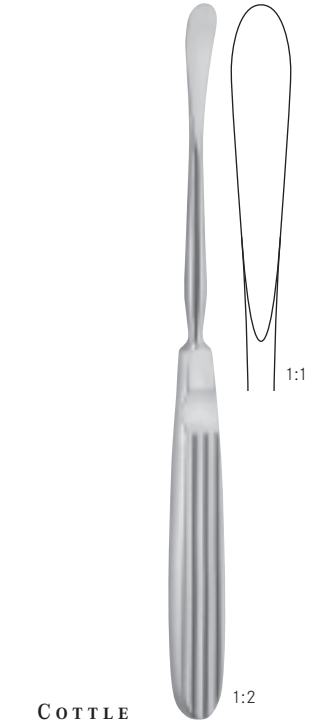

COTTLE

	x = 8 mm
190 mm – 7½"	tk 51607-19

scharf
sharp
tranchant
cortante
acuta

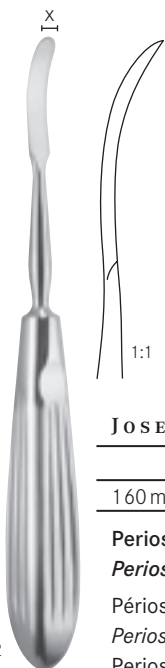

JOSEPH

	x = 5 mm
160 mm – 6¼"	tk 51613-16

Periost Elevatorien
Periostal elevators
Périostotome
Periostotomo
Periostotomo



SEWALL

200 mm – 8"	tk 51610-20
-------------	--------------------

Antrum Elevatorium
Antrum elevator
Élévateur pour le fosse nasale
Elevador para el antro
Elevatore per antro



HALLE

160 mm – 6¼"	tk 51617-16
--------------	--------------------

Septumelevatorien – Raspatorien
Septum elevators – raspatories

Elevateurs – rugines pour la cloison nasale
Elevadores – legras para el tabique nasal
 Elevatori – periostotomi per setto

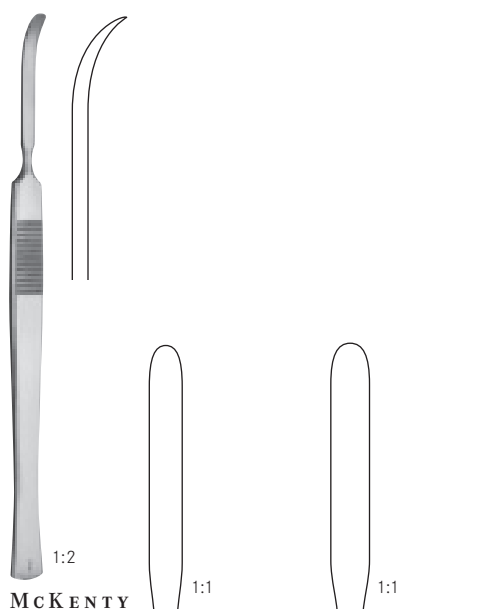

MCKENTY	4 mm	5 mm
150 mm – 6"	tk 51619-04	tk 51619-05

scharf
sharp
 tranchant
cortante
 acuta



COTTLE	x = 5 mm
235 mm – 9¼"	tk 51620-23

scharf
sharp
 tranchant
cortante
 acuta



MCKENTY	x = 4 mm
205 mm – 8"	tk 51621-22

scharf
sharp
 tranchant
cortante
 acuta

Septumlevatorien – Raspatorien
Septum elevators – raspatories

Elevateurs – rugines pour la cloison nasale
Elevadores – leguas para el tabique nasal
Elevatori – periostotomi per setto



KILIAN

1:2

1:1

x = 4 mm

180 mm – 7"

tk 51622-18

scharf/stumpf
sharp/blunt

tranchant/mousse
cortante/romo
acuta/smussa



KILIAN

1:2

1:1

x = 4.5 mm

230 mm – 9"

tk 51623-22

scharf/stumpf
sharp/blunt

tranchant/mousse
cortante/romo
acuta/smussa



FREER

1:2

1:1

190 mm – 7½"

tk 51625-19

stumpf
blunt

mousse
romo
smussa

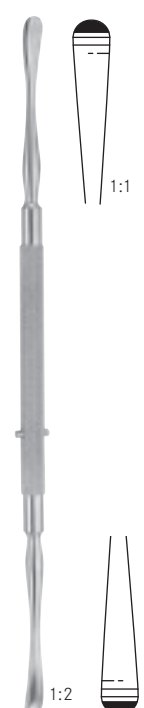

FREER

1:2

1:1

180 mm – 7"

tk 51627-18

scharf/stumpf
sharp/blunt

tranchant/mousse
cortante/romo
acuta/smussa

Septumelevatorien – Raspatorien
Septum elevators – raspatories

Elevateurs – rugines pour la cloison nasale
Elevadores – leguas para el tabique nasal
 Elevatori – periostotomi per setto



FREER

205 mm – 8"

tk51631-20

scharf/stumpf
sharp/blunt
 tranchant/mousse
cortante/romo
 acuta/smussa



PENNINGTON

215 mm – 8½"

tk51629-21

stumpf
blunt
 mousse
romo
 smussa



JOSEPH-MASING

215 mm – 8½"

tk51634-22

scharf
sharp
 tranchant
cortante
 acuta

Periostelevatorien
Periosteal elevators

Elevateurs pour la périoste
Legras para periostio
Elevatori per il periosto



MASING

200 mm - 8"	tk 51636-21
-------------	--------------------

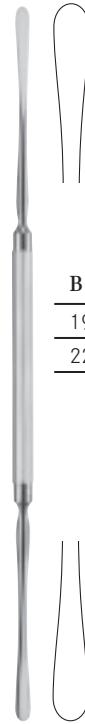

BALLENGER-HAJEK

190 mm - 7¼"	tk 51637-19
220 mm - 8¾"	tk 51637-22



COTTLE

220 mm - 8¾"	tk 51643-22
--------------	--------------------

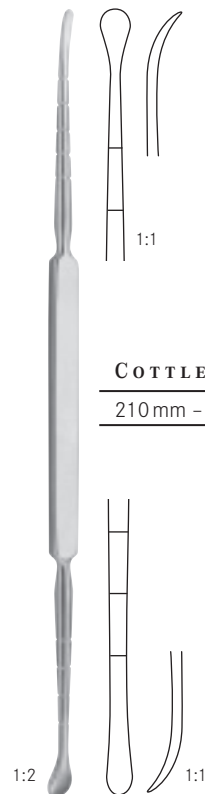

COTTLE

210 mm - 8¼"	tk 51644-21
--------------	--------------------

Hämmer
Mallets

Maillets
Martillos
Martelli



PARTSCH

	22 mm Ø - 200 g
180 mm - 7"	tk 24053-18

1:2



	20 mm Ø - 140 g
165 mm - 6½"	tk 24055-16

1:2



	25 mm Ø - 205 g
190 mm - 7½"	tk 24056-19

Stahl massiv, mit Kunststoffbacken
steel solid, with plastic faces
acier solide, avec plaques en plastic
acero solido, con placas en plastica
acciaio massiccio, con placche di plastica

1:2

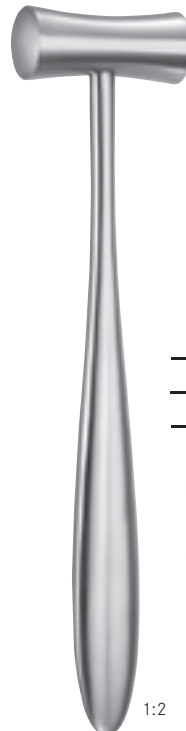

LUCAE

	19 mm Ø - 230 g	25 mm Ø - 260 g
190 mm - 7½"	tk 24057-01	tk 24057-02

Stahl massiv
steel solid
acier solide
acero solido
acciaio massiccio

1:2

Knochenmeißel
Bone chisels and gouges

Ciseaux-burins, gouges
Cinceles, gubias
Scalpelli, sgorbie



MINI-LAMBOTTE

	125 mm - 5"	170 mm - 6¾"
3 mm	tk 24094-03	tk 24095-03
4 mm	tk 24094-04	tk 24095-04
6 mm	tk 24094-06	tk 24095-06
8 mm	tk 24094-08	tk 24095-08
10 mm	tk 24094-10	tk 24095-10
12 mm	tk 24094-12	tk 24095-12
15 mm	tk 24094-15	tk 24095-15



MINI-LEXER

	180 mm - 7"	180 mm - 7"
4 mm	tk 24086-04	tk 24087-04
6 mm	tk 24086-06	tk 24087-06
8 mm	tk 24086-08	tk 24087-08
10 mm	tk 24086-10	tk 24087-10
12 mm	tk 24086-12	tk 24087-12

Ferrozellgriff

Ferrozell handle

Manche en Ferrozell

Mango en Ferrozell

Manico di Ferrozell

Knochenmeißel
Bone chisels and gouges

Ciseaux-burins, gouges
Cinceles, gubias
Scalpelli, sgorbie

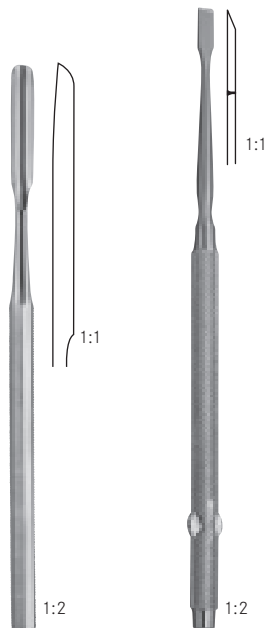

FREER

	150 mm - 6"	160 mm - 6¼"
6 mm	tk 24251-15	
4 mm		tk 24252-16

Hohlmeißel
Gouge
Gouge
Gubia
Sgorbia

Flachmeißel
Chisel
Ciseau-burin
Cinzel
Scalpello

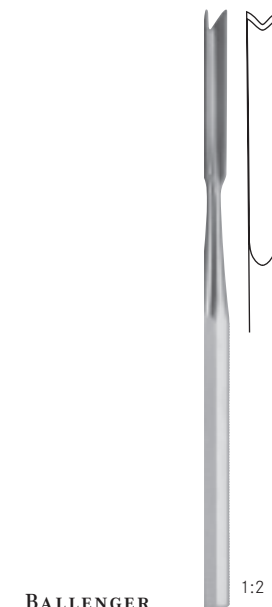

BALLENGER

	160 mm - 6¼"
4 mm	tk 24255-04
6 mm	tk 24255-06
8 mm	tk 24255-08



1:2

**MANNERFELT
MODIF.**

	155 mm - 6"	155 mm - 6"
3 mm		tk 24254-03
4 mm	tk 24253-04	
6 mm	tk 24253-06	
8 mm	tk 24253-08	

Osteotome
Osteotomes
Ostéotomes
Osteótomos
Osteotomi

Hohlmeißel
Gouge
Gouge
Gubia
Sgorbia

Osteotome und Flachmeißel
Chisels, osteotomes for rhinoplasty

Ostéotomes, ciseaux-burins pour rhinoplastique
Cinceles para rinoplastica
Scalpelli per plastica nasale



KILIAN

1:2

160 mm - 6¼"

5 mm

tk 24261-16



KILIAN-CLAUS

1:2

160 mm - 6¼"

5 mm

tk 24263-16



COTTLE

150 mm - 6"

7 mm

tk 24270-07

12 mm

tk 24270-12



COTTLE

1:2

190 mm - 7½"

4 mm

tk 24272-19

6 mm

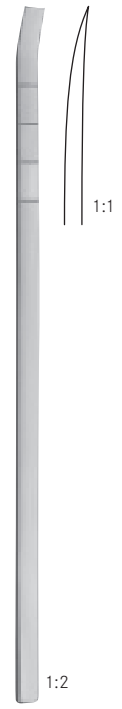

1:2

180 mm - 7"

tk 24277-06



1:2

FOMON



4 mm



5 mm



6 mm

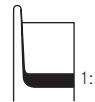

7 mm

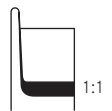

8 mm

170 mm - 6¾"

tk 24278-04

tk 24278-05

tk 24278-06

tk 24278-07

tk 24278-08

Osteotome und Flachmeißel
Chisels, osteotomes for rhinoplasty

Ostéotomes, ciseaux-burins pour rhinoplastique
Cinceles para rinoplastica
Scalpelli per plastica nasale



1:2

CINELLI	10 mm	12 mm	14 mm	16 mm
180 mm - 7"	tk 24279-10	tk 24279-12	tk 24279-14	tk 24279-16



1:2

COTTLE	4 mm	7 mm	9 mm	12 mm
180 mm - 7"	tk 24280-04	tk 24280-07	tk 24280-09	tk 24280-12

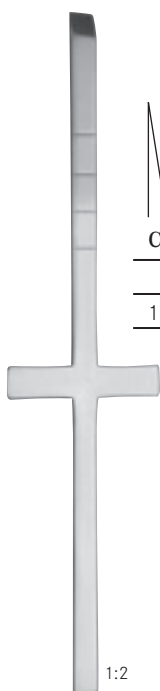

1:2

COTTLE	4 mm	7 mm	9 mm	12 mm
180 mm - 7"	tk 24281-04	tk 24281-07	tk 24281-09	tk 24281-12

Osteotome und Flachmeißel
Chisels, osteotomes for rhinoplasty



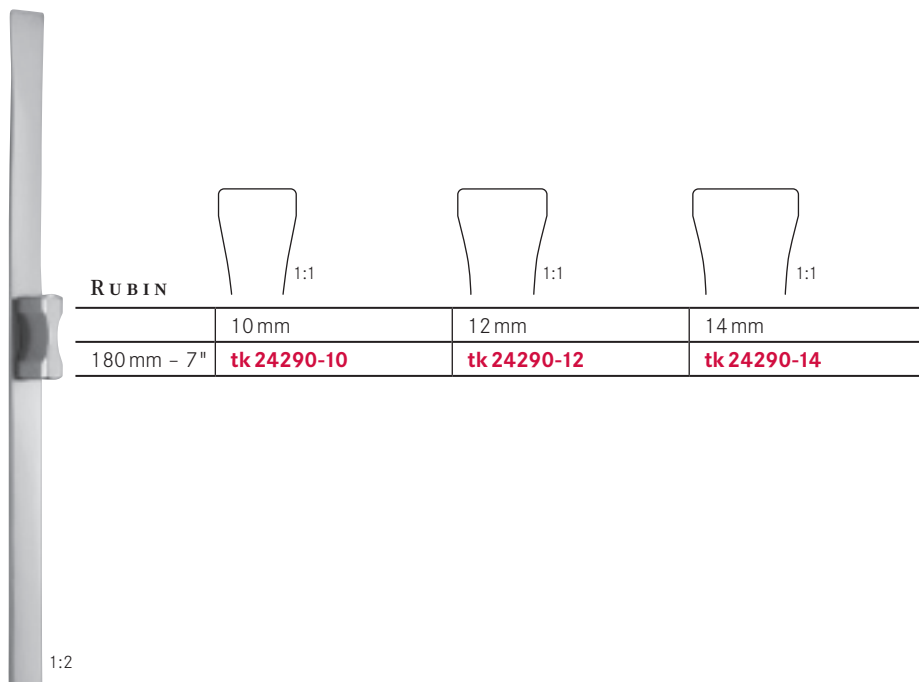
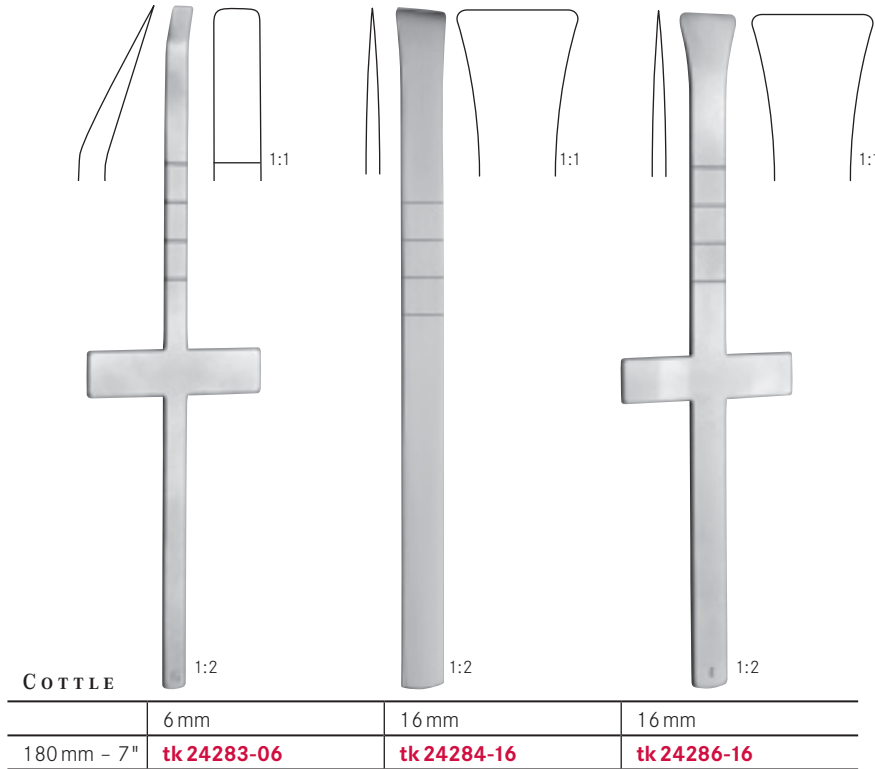

Ostéotomes, ciseaux-burins pour rhinoplastique
Cinceles para rinoplastica
Scalpelli per plastica nasale



Osteotome und Flachmeißel
Chisels, osteotomes for rhinoplasty

Ostéotomes, ciseaux-burins pour rhinoplastique
Cinceles para rinoplastica
Scalpelli per plastica nasale





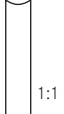
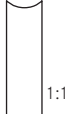

COTTLE	 1:1	 1:1	 1:1	 1:1
	200 mm - 8"	4 mm tk 24287-04	7 mm tk 24287-07	9 mm tk 24287-09



WALTER	 1:1	 1:1
	190 mm - 7½"	3 mm tk 24292-03

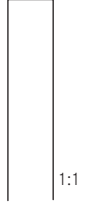
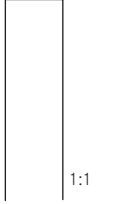

SHEEHAN	 1:1	 1:1	 1:1	 1:1
	160 mm - 6¼"	2 mm tk 24295-02	4 mm tk 24295-04	6 mm tk 24295-06

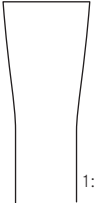
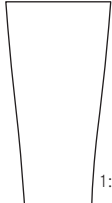
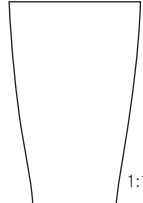
 1:1	 1:1	 1:1	 1:1
10 mm tk 24295-10	12 mm tk 24295-12	15 mm tk 24295-15	18 mm tk 24295-18

Osteotome und Flachmeißel
Chisels, osteotomes for rhinoplasty

Ostéotomes, ciseaux-burins pour rhinoplastique
Cinceles para rinoplastica
ScalPELLI per plastica nasale



1:2

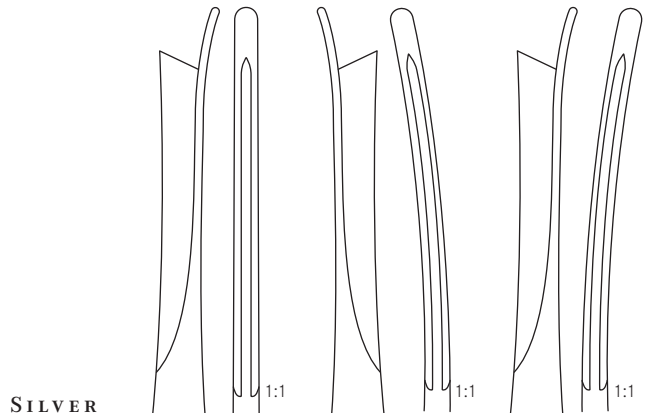

SILVER

180 mm - 7"

tk 24296-01

tk 24296-02

tk 24296-03

gerade
straight

rechts
right

links
left

droit
recta
retta

droite
derecha
destra

gauche
izquierda
sinistra



1:2

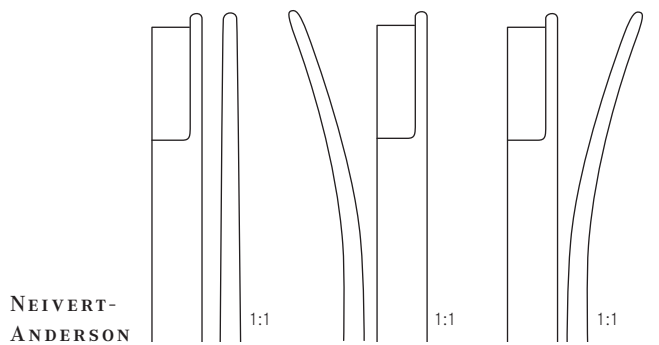

NEIVERT-ANDERSON

200 mm - 8"

tk 24298-01

tk 24298-02

tk 24298-03

gerade
straight

rechts
right

links
left

droit
recta
retta

droite
derecha
destra

gauche
izquierda
sinistra